

PRODUCT SPECIFICATION

SD 1110/360R INPUT/DISPLAY TERMINAL

WITH AN

IBM SYSTEM/360 COMPATIBLE INTERFACE

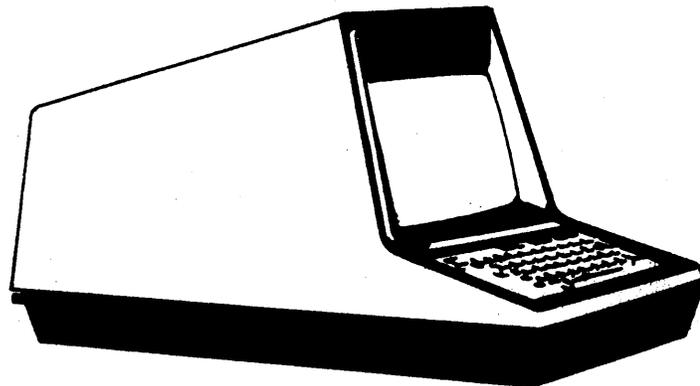

Stromberg DatagraphiX, Inc.

A GENERAL DYNAMICS SUBSIDIARY

P. O. BOX 2449 SAN DIEGO, CALIFORNIA 92112

9500515
Product Specification
Engineering Release
Revision 3 1-2/69

PRODUCT SPECIFICATION
FOR THE
SD 1110/360R INPUT/DISPLAY TERMINAL
WITH AN
IBM SYSTEM/360 COMPATIBLE INTERFACE

January 1969

Stromberg Datagraphix, Inc.

A GENERAL DYNAMICS SUBSIDIARY

P.O. BOX 2449 SAN DIEGO, CALIFORNIA 92112

TABLE OF CONTENTS

<u>SECTION</u>		<u>PAGE</u>
I	SCOPE	1-1
II	PURPOSE	2-1
III	GENERAL DESCRIPTION	3-1
	3.1 Control Unit	3-1
	3.2 Display Unit	3-1
IV	FUNCTIONAL DESCRIPTION	4-1
	4.1 Display Characteristics	4-1
	4.2 General Keyboard/Display Operation	4-3
	4.3 Detailed Keyboard Operation	4-5
	4.3.1 Data Keys	4-7
	4.3.2 Edit Keys	4-7
	4.3.3 Control Keys	4-9
	4.3.4 Illuminated Indicators	4-10
	4.3.5 Special Rules of Key Operation	4-10
	4.3.6 Audible Alarm	4-11
	4.3.7 Keyboard Locking	4-11
V	TERMINAL/PROCESSOR COMMUNICATIONS	5-1
	5.1 Transmission of Text Data from the Terminal Memory	5-2
	5.1.1 Control of Text Data in Read Sequences	5-2
	5.2 Transmission of Data to the Terminal Memory	5-4
	5.2.1 Memory Overflow	5-5
	5.2.2 Screen Blanking	5-6
	5.2.3 Error Detection	5-6
	5.3 Character Codes and Formats	5-7
	5.3.1 Graphic Characters	5-9
	5.3.2 Format Effectors	5-11
	5.3.2.1 Closed Format (CF)	5-11
	5.3.2.2 Start Protect (STP), End Protect (EP)	5-12

<u>SECTION</u>		<u>PAGE</u>
V	5.3.2.3 Nonsignificant Space (NS)	5-12
(cont)	5.3.2.4 Line Feed (LF)	5-12
	5.3.2.5 Generate XX Non-Significant Spaces (GNS XX)	5-13
	5.3.3 Control Characters	5-13
	5.3.4 Program Controlled Display Modes	5-13
	5.3.4.1 Closed Format Mode	5-14
	5.3.4.2 Variable Format Mode	5-17
	5.4 Sequences and Responses	5-18
	5.4.1 Common Sequence Summary	5-31
VI	TERMINAL CONFIGURATION	6-1
VII	PHYSICAL DESCRIPTION	7-1
	7.1 Construction	7-1
	7.2 Dimensions and Weight	7-1
	7.3 Finish and Color	7-1
	7.4 Floor Space Requirements	7-1
	7.5 Power Requirements	7-1
	7.6 Environmental Conditions	7-2
APPENDIX A	A-1
APPENDIX B	B-1
APPENDIX C	C-1

ILLUSTRATIONS

<u>FIGURE</u>		<u>PAGE</u>
1-1	SD 1110/360R Input/Display Terminal	1-2
3-1	SD 1110/360R Input/Display Terminal Block Diagram	3-2
4-1	Display Screen	4-2
4-2	Keyboard Engraving	4-6

ILLUSTRATIONS (cont)

<u>FIGURE</u>		<u>PAGE</u>
5-1	Sequence/Response Diagram - Specific Poll - OF or VF Mode	5-19
5-2	Sequence/Response Diagram - Specific Poll - CF Mode	5-21
5-3	Sequence/Response Diagram - Read Memory - OF and VF Modes	5-23
5-4	Sequence/Response Diagram - Read Memory - CF Mode	5-25
5-5	Sequence/Response Diagram - Erase/Write - All Modes	5-27
5-6	Sequence/Response Diagram - Write - OF Mode Only	5-29
6-1	Typical Remote Single Terminal	6-2
6-2	Typical Remote 2 to 4 Terminal Complex	6-3
6-3	Typical Remote 5 to 13 Terminal Complex	6-4
6-4	Typical Remote 3 to 5 Terminal Complex	6-5

LIST OF TABLES

<u>TABLE</u>		<u>PAGE</u>
5-1	SD 1110 Code Set	5-8
5-2	Text Library Characters and Codes	5-9
5-3	Format Effectors	5-11
5-4	Common Read Sequences	5-32
5-5	Common Write Sequences	5-34

SECTION I

SCOPE

This specification describes the performance and physical characteristics of an SD 1110/360R Input/Display Terminal with an IBM System/360 Compatible Interface. It also provides functional information for use in systems design and programming for a Terminal Complex as well as installation planning data. Detailed BTAM programming information is available in a separate manual. The SD 1110/360R Input/Display Terminal is shown in Figure 1-1.



4011

Figure 1-1. SD 1110/360R Input/Display Terminal

SECTION II

PURPOSE

The SD 1110/360R is one model of a family of SD 1110 Input/ Display Terminals manufactured by Stromberg Datagraphics, Inc. It is designed specifically for entry and retrieval of alphanumeric data in conjunction with an IBM System/360. The Model 360R Input/Display Terminal is a "Stand Alone" configuration (a complete terminal unit capable of direct connection to Western Electric Data Set 201B). The Specific System/360 Interface for which the equipment is designed is an IBM 2701 Data Adapter Unit with a Start/Stop Terminal Adapter, Type III, Number 4657. The SD 1110/360R Terminal can be connected as an alternate to the IBM 2848 Display Control/9013 Data Set Adapter configuration. They may be installed singly or in groups at each remote Data Set location. Group installations require the use of the SD 1110/DSD Data Set Distributor. A Common Carrier Schedule 4, C4 Conditioning, four wire leased private-line telephone service and a minimum of two Data Sets are required for remote operation. The SD 1110/DSS Data Set Simulator can be used to eliminate the need for Data Sets where all Terminals on a single Type III Adapter are installed in close physical proximity from the System/360.

SECTION III

GENERAL DESCRIPTION

The SD 1110/360R is contained in two separate units: a Control Unit (CU), and a Display Unit (DU). The DU can be positioned on top of the CU which acts as a desk, or it can be operated remotely up to 50 feet from the CU.

3.1 CONTROL UNIT

The CU contains a Display Control section which generates all the timing and control signals for the CRT Display and Keyboard, an Interface section which controls the routing and accuracy checking of data/control communication interchanges, and the delay line Memory for display reiteration as illustrated in Figure 3-1. Data can be written into the Memory locally from the Keyboard or remotely from the communications link via the Interface. Data also can be read from the Memory through the remote path.

3.2 DISPLAY UNIT

The DU contains the Keyboard and controls necessary to compose, edit, and make data inputs to the data processing system plus a CHARACTRON® Shaped Beam Tube (CSBT) Display with self-contained power supplies and character decoding and deflection circuitry---also illustrated in Figure 3-1. The contents of the delay line Memory are displayed on the CHARACTRON® screen which provides 2880 character positions. Within these positions, up to 1079 characters can be presented in a stable, flicker-free display.

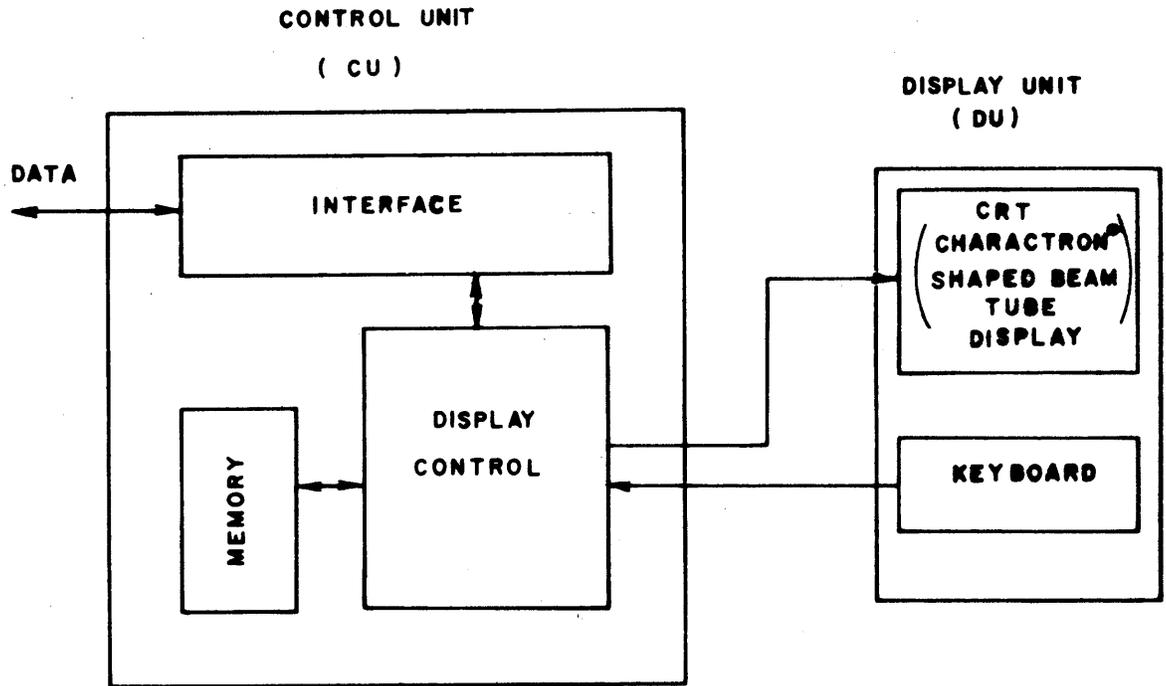

Figure 3-1. SD 1110/360R Input/Display Terminal Block Diagram

SECTION IV

FUNCTIONAL DESCRIPTION

4.1 DISPLAY CHARACTERISTICS

The Cathode Ray Tube used is a CHARACTRON® Shaped Beam Tube (CSBT) with a 10- by 10-inch display screen and a type P31 phosphor, as shown in Figure 4-1. The normal capacity of the screen is 36 lines of 80 characters each. A few more than 36 lines can be displayed before the lower visible limits of the screen are reached. Those lines displayed in excess of 36 will still be legible although they will flicker, i.e., they will be refreshed at a rate of 25 Hz--half the normal rate of 50 Hz. The characters are nominally 0.120 inch high. The maximum number of characters which can be displayed is 1079, including Line-Feed (LF) characters which are not displayed as a special symbol, but create an effect on the display equivalent to a line feed and carriage return combined.

The character Brightness at the phosphor surface is approximately 40 foot-lamberts. A filter is used over the faceplate to enhance the contrast for optimum viewing in a normal ambient of 50 to 100 foot-candles.

Displayed lines always begin at the left margin and can be terminated after any number of characters equal to or less than 80 by the entry of the LF character. Neither the entry of blanks nor their storage in the Memory is required to fill out the remainder of any line less than 80 characters; thus, the full capacity of the Memory can be used for active display. An LF character will automatically be inserted (by internal control) if entry of over 80 characters on a single line is attempted.

Subsequent characters entered will be displayed on the next line.

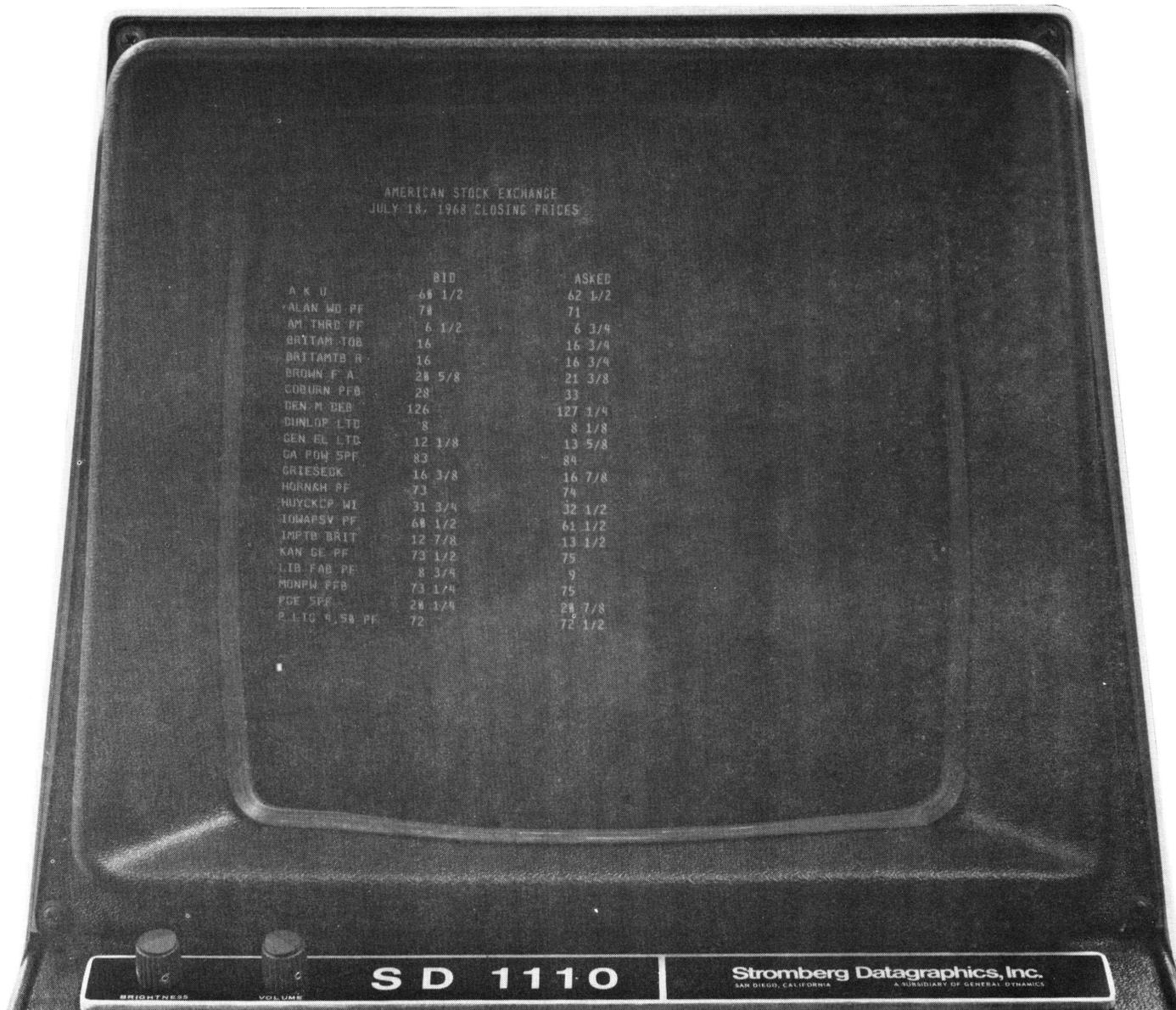

4021

Figure 4-1. Display Screen

The CRT screen reproduces the content of the Memory in printed form except during certain short periods of communication when the display may be blanked.

Characters can be entered into the Memory from the Keyboard and from the Processor via the communication link and Interface section of the CU. The screen can be erased (cleared) from the Keyboard or from the Processor, and data on the screen may be modified by a number of edit procedures from the Keyboard.

4.2 GENERAL KEYBOARD/DISPLAY OPERATION

The keys are classified into three general groups, Data Keys, Edit Keys, and Control Keys. The Data Keys enter data into the Memory. The Edit Keys move the Cursor and permit replacing, inserting, and deleting characters in the displayed text. The Control Keys provide for partial and complete erasure, modification of the data entered by the Data Keys, and transmission of data to the Processor.

The screen displays the content of Memory. The Cursor (a solid rectangle) will normally be displayed on the screen. After the screen is cleared, it will always appear at the left margin on the first line. As entries are made (into Memory) with the Data Keys, the characters will replace the Cursor and the Cursor will advance, always appearing one character position after the last entry. This position will be referred to as End of Displayed Text (EDT). The Cursor will appear steady (non-flickering) in this EDT position. After entries have been made, the Cursor can be moved back into the text by use of the Edit Keys. There it will be displayed at 12.5 Hz and will appear to flicker. It will then be superimposed over a text character which will remain legible through the flickering Cursor. Striking a Data Key at this time will replace this character at the Cursor position, and the Cursor will advance. Deletions are made by striking the DLT key with the Cursor over the character to be deleted. The character will be deleted, the text will close up, (only on the line involved in the deletion), and the Cursor will not advance. If an LF is deleted, the lines below

will close up, and LF's will automatically be inserted as necessary to limit all line lengths to 80 characters.

Single or multiple insertions are made by first placing the Display Control in the Insert mode through a single use of the INS key at the beginning of the insert operation. In the Insert mode, the Data Keys will insert characters ahead of the Cursor position, the text (only for the line involved) will expand, and the Cursor will advance. If the insert action is continued until 80 characters are contained on the line, the next Data Key action will insert a new line for the overflow and all lines below will move down one line. Further insertions will cause the line overflow to appear on the new line created. When the new line overflows, additional overflow lines are created as needed in the same way.

The Insert mode will be entered automatically if a Data Key is struck when the Cursor is on an LF character. This greatly simplifies the process of appending characters to a line by not affecting the line structure below. Even where the 80-character line limit must be exceeded, all lines below will move down without any change in the line length structure. The Insert mode will continue until cleared by operating any key other than a Data Key or the INS Key.

The flickering of the Cursor during "Edit" operations makes it easy to locate with minimum eye scanning. Its nonflickering appearance, while the usual sequential entries are being made at EDT, is helpful in identifying the EDT in cases where the text ends in blanks or carriage returns. The Cursor can be manipulated by Keyboard edit controls only to areas of the screen where characters are being displayed, i.e., within the limits of the existing display, but not to positions where there is no corresponding data in the Memory.

Edit Keys have a repeat or "slew" action (also optional with Data keys - see Appendix A) where faster or more convenient operation can be effected.

The effect on the display of some of the keys, particularly those controlling the Cursor, is dependent on the display mode. There are three general modes of display, Open Format (OF), Closed Format (CF), and Variable Format (VF). These will be described briefly here and in more detail in later sections.

The OF mode is always established when Keyboard entries are made after the screen has been cleared. It can also be established by the Processor. In OF mode, the Cursor can be moved to any displayed character by the use of Edit Keys.

The VF and CF mode can only be established by the Processor since the characters required are not available from the Keyboard. In VF mode, the Cursor is restricted from protected areas (fields) written by the Processor through the use of Start Protect and End Protect characters. These characters establish the VF mode. The entry of data from the Keyboard and the positions available to the Cursor are otherwise the same as in OF mode.

The CF mode is established when the CF character is the first character written in Memory. Protected areas are optional. The Cursor is restricted from protected areas (if used) and is also always strictly limited to the unprotected areas initially written by the Processor. Additional features of the three modes will be discussed in detail in the paragraphs of CF and VF modes.

4.3 DETAILED KEYBOARD OPERATION

The SD 1110/360R Keyboard consists of 46 keys arranged in six rows, a DU power ON/OFF switch, a brightness control (early models only) and a volume control for the audible alarm. The keys include 42 Alphanumerics/Symbols, 8 Edit, Space Bar, Carriage Return, Shift, Control, Transmit and Reset. Key-top engraving is shown in Figure 4-2.

The detailed operation of the Keyboard as described in the following paragraphs applies strictly to the OF mode of display. There are slight differences which apply

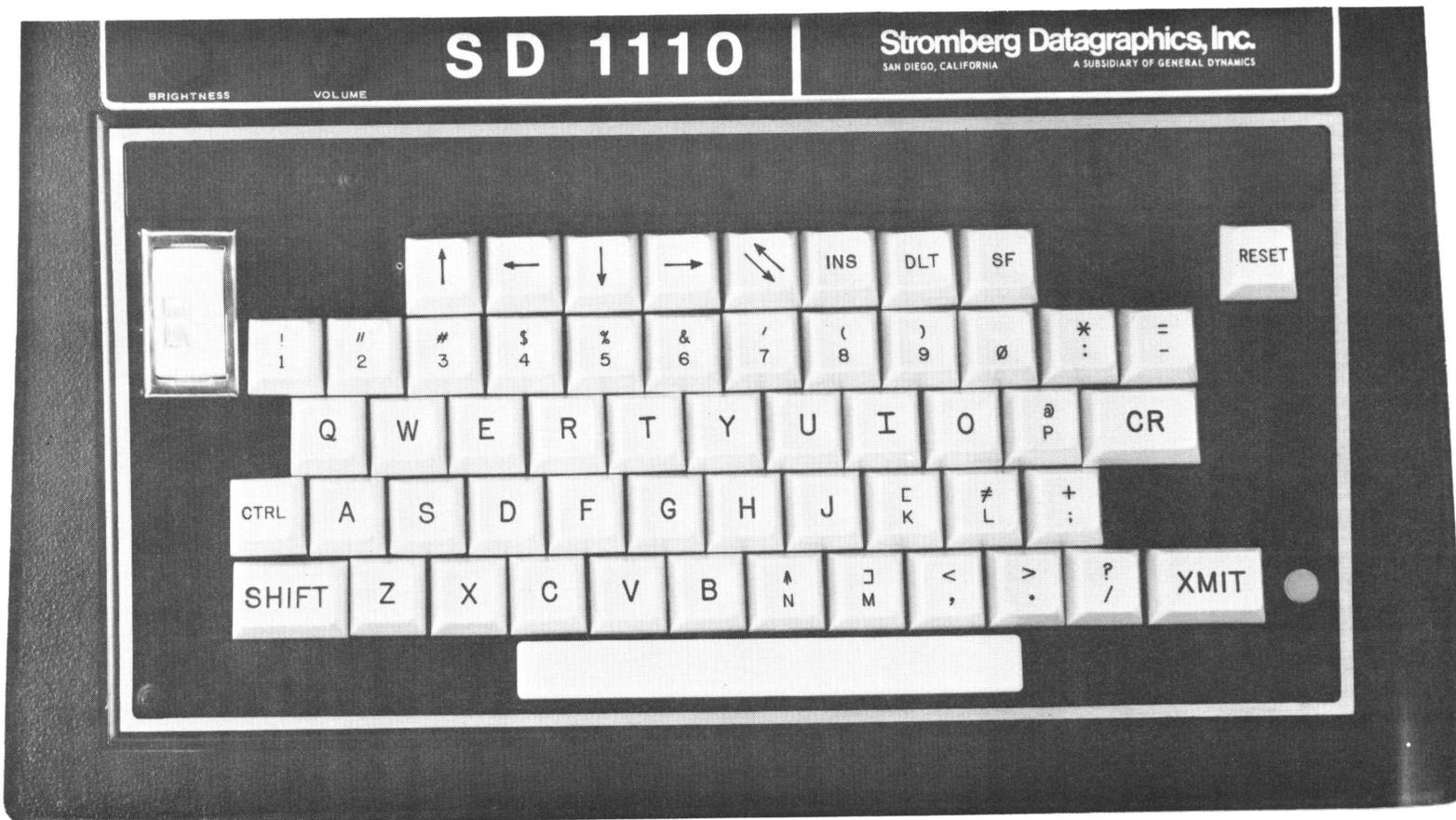

3857-A

Figure 4-2. Keytop Engraving

specifically to the VF and CF modes of display. The differences, and also differences in communication, will be discussed in a later section.

4.3.1 Data Keys

The Data Keys are the only keys which enter data (characters) into the Memory. All Data Key actions display a visible character or affect the display in a way which is visible. The Space Bar key creates a blank, and the Carriage Return (CR) key resets the line scan in the usual fashion and also causes a line feed. (NOTE: The CR key on some keyboards is labeled RETURN.) The Data Keys are marked according to the symbol displayed. They comprise all of the keys except the top row and CTRL, SHIFT and XMIT. Alternate data, where available by simultaneous use of the SHIFT key, is marked on the keys above the nonshift symbol. Data may be entered by the Data Keys until the Memory is filled. When the Memory is full, the Cursor will flicker and if further entries are attempted, the last character will be changed with each key-stroke, i.e., key entries will not wrap around to the top of the display.

4.3.2 Edit Keys

The Edit Keys control the Cursor position, set the mode of Keyboard operation to Insert, or make deletions. The following is a description of the function of each specific Edit Key:

- **DIAGONAL ↖**

Places the Cursor in the last position in which it is possible to make a Keyboard entry (EDT in OF mode).

-With Control (CTRL) key

Places the Cursor in the first position in which it is possible to make a Keyboard entry.

- **LEFT ←**

Moves the Cursor back one character position. The Cursor will wrap around to the end of the preceding line or from the left end of the top line to the right end of the bottom line.

- **RIGHT→**

Causes the Cursor to move forward one character position. The Cursor will wrap around from the right end of a line to the left margin of the next line and also from the right end of the bottom line to the left end of the top line.

- **DOWN↓**

Causes the Cursor to position on the first character of the next line down. The Cursor will wrap around to the top of the screen.

- **UP↑**

Causes the Cursor to move to the first character position of the line above. The Cursor will wrap around to the last line.

- **INSERT (INS)**

Places the Display Control in Insert mode. In the Insert mode Data Keys will insert characters into the displayed text immediately preceding the Cursor, the text of that line only will spread, and the Cursor will advance. If 80 characters are exceeded on the display line, an LF will automatically be inserted, a new line will be created, and the line structure below will remain unchanged and move down one line. The Display Control remains in Insert mode until it is cleared by the use of a key other than a Data Key, the INS key, or the RESET key. An unlimited number of insertions can be made with only one depression of the INS key. When the insertion process in one location is complete, the Cursor would usually be moved to a new position using one of the Edit Keys--or the XMIT key would be used. This automatically stops further insertions by clearing the Insert mode in the Display Control.

- **DELETE (DLT)**

Deletes the character under the Cursor and closes up only the line of text involved. If an LF character is deleted, the lines below will move up and additional LF's will be automatically inserted to limit all line lengths to 80 characters.

4.3.3 Control Keys

The Control Keys do not enter data into the Station Memory but provide for complete or partial erasure, modification of data entered by the Data Keys, and transmission of data to the Processor as described below:

- **START FROM (SF)**

Repositions the Unload Marker (UM) to the Cursor position and places the Display Control in Partial mode.

In the Partial mode the UM position will be displayed by a (#) symbol flashing over the displayed character on which the UM is positioned in Memory. This specifies the starting point in the displayed data for reading by the Processor by means of a Poll. (See Paragraph 5.2.1) The UM can be repositioned as many times as desired; however, there will be only one at a time in Memory. The Partial mode can be cleared only by RESET or CTRL/RESET from the Keyboard or by control from the Interface generated as a result of a proper response from the Processor--an ETX character.
- **TRANSMIT (XMIT)**

Conditions the Display Control by establishing a Request Out (RO) condition so that the Terminal will generate a READ sequence in response to a Poll from the Processor. The Cursor will jump to EDT when XMIT is depressed unless the Partial mode is set. (NOTE: A simple wire change option is also available to cause the Cursor to jump to EDT when in Partial mode. See Appendix A, Option Summary). The indicator lamp adjacent to the XMIT key will go out and remain out until the entire transaction is complete as indicated by the reception of an ETX from the Processor.
- **SHIFT**

Combined use of the SHIFT key and any alphanumeric key marked with an upper inscription causes that key's upper symbol to be entered.

- CONTROL (CTRL)

Combined use of the CTRL key and the Diagonal or RESET keys modifies their function as described in this section, It also speeds up the rate of the repeat action of Left, Right, and DLT keys. (See Slew - Paragraph 4.3.5.)

- RESET

Depressing the RESET key alone for more than 1/3 second will clear the variable data (applies only to CF mode) from the Memory and screen. The 1/3-second delay acts as a protection against accidental clearing of variable data. This is desirable because it is a single key action. Depressing the CTRL key and the RESET key (CTRL/RESET) will clear all data from the Memory and screen. RESET or CTRL/RESET keys will also clear the RO condition set by the XMIT key and the Partial mode set by the SF key.

4.3.4 Illuminated Indicators

- POWER ON/OFF

Indicates that power is applied to the DU. This indicator is incorporated in the power ON/OFF switch in some models.

- KEYBOARD ACTIVE (KBD ACT)

Indicates that Keyboard entries may be made. When this light is off, the Display Control is in an RO condition, in process of communication, or in a Wait Acknowledge (WACK) condition, and the Keyboard will be electrically locked. (See Paragraph 4.3.7.)

- SYSTEM AVAILABLE (SYS AVL)

This lamp will light each time the Terminal is addressed. This light activity will indicate to the operator that the Processor is operating and normal responses may be expected.

4.3.5 Special Rules of Key Operation

- SLEW

Left, Right, Down, and Up keys will slew (repeat action) at 12-1/2 Hz, and the DLT key will slew at 25 Hz after it has been depressed for more than 1/3 second. The DLT

key will not slew past an LF without a second depression of the DLT key. This prevents inadvertently erasing more than one line. With the CTRL key also depressed, the Right and DLT keys will slew at 50 Hz and the Left key will slew at 25 Hz.

- **AUTOMATIC INSERT**

When the Cursor is positioned on an LF character, use of a Data Key will place the Display Control in Insert mode before storing the character in Memory. Automatic LF insertion is still effective at the end of an 80-character line and the lines below are pushed down.

The net effect of Automatic Insert is to simplify appending a line in text, since it is done in exactly the same way as adding to EDT and does not disturb the structure of the lines below. The only time the INS key must be used is when inserting within a line of text.

4.3.6 Audible Alarm

An Audible Alarm will indicate when the Keyboard entry is within four characters of the end of a line.

4.3.7 Keyboard Locking

The Keyboard will be locked under several conditions. The locking is electrical rather than mechanical, i.e., the keys can be depressed, but will have no effect. Not all the keys are locked. The Diagonal key is never locked. The RESET and CTRL/RESET are locked only during actual transfer of data between the Processor and the Memory. All other keys are locked under any of three conditions: (1) data transfer, (2) Request Out (RO), and (3) Wait Acknowledge (WACK). The WACK condition is set automatically after a Read sequence and is cleared by acknowledgment from the Processor in the form of an ETX character, signifying an answer, or a release if no text precedes ETX.

SECTION V

TERMINAL/PROCESSOR COMMUNICATIONS

Data transfer between the Terminals and the Processor is under the master control of the Processor. The Processor will initiate all reading of data from the Terminal Memory and all writing of data into the Memory. Communication formats, codes, and timing are compatible with the IBM 2701 Data Adapter Unit with the Start/Stop Terminal Adapter, Type III, Number 4657. The Terminals may be used on the same communication line interchangeably with an IBM 2848 Display Control, and System/360 BTAM Macro Language can be used in programming. Data transmission is bit serial (10 bits per character) and character serial with start/stop individual character synchronization. 201B Data Sets are used at 2400 baud.

NOTE: Data transfer rates, as limited by the Terminal buffering capacity, can be as high as 3600 baud.

An Address sequence including a command code is always used to initiate an exchange of data between the System/360 Processor and the Terminal. The command codes that can be executed by the SD 1110/360R are as follows:

<u>SD 1110 COMMAND</u>	<u>CODE OCTAL</u>	<u>CODE HEX-ASCII-8</u>	<u>2848 EQUIVALENT COMMAND</u>
Poll	240	80 40	Specific Poll-2260 or General Poll
Write	300	A0	Write 2260
Erase/Write	140	E0	Erase/Write
Read Memory	060	50	Read Addressed Full DS Buffer

5.1 TRANSMISSION OF TEXT DATA FROM THE TERMINAL MEMORY

Transmission of data from the Terminal Memory to the Processor, via the 2701 and a System/360 Channel, is accomplished by one of two READ sequences. A READ sequence is initiated by a Poll or Read Memory command from the Processor. The Interface controls the sequences at the Terminal end response to the Channel commands. The two Read sequences result in two slightly different READ responses from the Terminal.

- The Read Memory (RM) response will read (transfer to the Channel) the entire contents of the Memory which may range from zero to 1079 characters.
- The Poll response may read any portion of the Memory. The particular portion read is controlled by both automatic means and the Keyboard. The Poll sequence is initiated by a Poll command from the Channel. This command will result in the transfer of Data from the Terminal Memory if the operator has depressed the XMIT key; if not, a "no traffic" response will be given by the Interface and no data from Memory will be transferred.

The Display Control will remain in a Wait Acknowledge (WACK) condition after a Poll response until cleared through the Interface by appropriate Channel response - ETX. This permits any number of repeats of the Poll response upon notification of transmission error from the Channel (the Channel response is the character NAK). When the WACK condition is cleared, the Display Control will move Control Markers in Memory that will set up proper conditions for subsequent Keyboard entries and Poll responses. This makes further repeats impossible without manual intervention at the Terminal. This is explained in more detail in the next section.

5.1.1 Control of Text Data in Read Sequences

The Poll response from the Terminal begins at a character location in Memory identified by an internal Memory marker (not displayed) called the Unload Marker

(UM). The ending location will always be another internal Memory marker called the Load Marker (LM) displayed as the Cursor. The UM will be moved automatically to EDT after a Poll sequence if the affirmative acknowledgment STX-EOT is received from the Channel. The LM will not be moved. STX-Text-ETX-LRC is also an affirmative acknowledgment. The control of the UM and LM for these responses and others is summarized in Table 5-4.

Using the Keyboard, the UM can also be placed anywhere within the displayed text by first placing the Cursor on the displayed character and then depressing the Start From (SF) key. This also places the Display Control in the Partial mode and will cause an SF symbol (#) to flash on the character. There are two available options affecting the Partial mode. A choice should be made when Terminals are ordered; however, options can be changed later by a field modification. If no initial choice is made, Alternate A will be supplied (See APPENDIX A - OPTION SUMMARY).

Option 1. When the XMIT key is depressed in the Partial mode, the Load Marker (indicated by the Cursor position) will:

(A) remain in its last location, provided this location is on or after the displayed # symbol, or if the Cursor is located ahead of the # symbol, it will jump to EDT when the XMIT key is depressed.

(B) jump to the end of displayed text (EDT).

Option 2. This option will:

(A) insert a character - ETB - ahead of the first text character read out whenever Partial mode has been used. This permits the Processor to identify the Partial action directly.

(B) not insert ETB.

In the RM response, the starting character location in Memory will always be the first character in Memory which is also the Start of Displayed Text (SDT), and the

ending location will always be the last character in Memory. Proper termination of an RM sequence (Channel response with the character EOT) will leave the display, UM, LM, and the Display Control modes unchanged. Table 5-3 summarizes the effects of this and other Channel responses. If an RM sequence is initiated by the Processor at a time when an RO condition is present, the Terminal will not respond. (NOTE: A Poll sequence could be used immediately before an RM sequence to clear the RO condition in case it existed.)

Both READ responses proceed within the Display Control and Memory on a character-by-character basis with an internally controlled temporary Unload Marker always identifying the next character to be read.

5.2 TRANSMISSION OF DATA TO THE TERMINAL MEMORY

The transfer of data from the Channel to the Terminal Memory, known as a WRITE sequence, is controlled by the Interface in response to a proper Command initiated from the Processor and transmitted via the Channel and 2701. The WRITE sequence stores the text data from the Channel into Memory. There are two types of WRITE sequences:

- The Erase/Write (EW) sequence first erases the existing Memory which clears the display screen. The new message is then stored and displayed starting at the upper left margin. (Same as SDT).
- The Write (WT) sequence stores the text data in the Memory starting at the current position of the LM. If the LM is at EDT this will "add on" to the existing display. If the LM were within the displayed text, the action would be that of overwriting (replacing) the existing display from the LM on, and any existing characters beyond the last character written would be automatically erased from the screen. The WT is normally a response to a previous Poll sequence which requested data from the Processor. The data returned will then appear as a continuation of display immediately following the request.

At the termination of a WRITE sequence (either EW or WT) without error, the LM and the UM will be moved to the end of the Processor response, i.e., the text just written. This facilitates operation in a "conversational" mode where only the most recent Keyboard entry is read by the Channel in the next READ sequence and a following WT sequence again adds the Processor response to the display, etc. When an error in a WRITE sequence is detected, the Interface causes the Display Control to move the LM (which marks the end of the error text just written) to the UM (which marks the beginning of the text just written). A repeat WT sequence will then write directly over the previous one in error. Under some circumstances some residual displayed characters could remain after such a repeat WT operation. Because of this possibility the Display Control will erase all characters beyond the last character written in a WT sequence.

5.2.1 Memory Overflow

In either the EW or the WT sequence the text may be large enough to exceed the Memory capacity. When the Memory Full condition is reached, the Display Control will ignore all subsequent text characters received in the data stream.

In addition, it will detect when the condition is reached or exceeded where there is one character storage position remaining in Memory. The Interface will respond to the Channel with an EOT to identify the nominal Memory overflow condition. The Display Control will subsequently refuse to accept further WT sequences until the Memory is cleared either from the Keyboard or by an EW sequence.

The number of characters required to fill the Memory varies with the number of display lines used. It can be calculated exactly by:

$$N = 1105 - 2LF$$

where: N = number of characters; counting all Line-Feed characters either sent to the Memory in text

from the Processor or added by the automatic Display Control editing.

LF = number of Line Feed characters.

For example, if the display were 13 full 80-character lines plus 39 characters on the fourteenth line, N would be 1079 which is the absolute maximum number of characters that can be displayed.

The maximum number of characters that can be accumulated in the Memory at the end of an EW or WT action without triggering the nominal Memory overflow detection is:

$$N = 1103 - 2LF$$

However, the Memory will actually hold two more characters which can be displayed. The Memory can also be filled from the Keyboard.

5.2.2 Screen Blanking

During a WRITE sequence the screen is blanked. After the WRITE sequence is completed the screen is unblanked a line at a time as the Display Control edits the text and completes the insertion of LF characters and nondisplay characters which provide time for the display deflection "flyback" for each line.

5.2.3 Error Detection

WRITE sequences are monitored in the Display Control, for character parity using the Vertical Redundancy Check (VRC) bit. Characters in error are stored in Memory as ASCII 7/15 which is displayed as the rectangular error symbol. If an error is detected, the LM is moved to the UM. Also during the WRITE sequence, the interface monitors for text errors by checking the Longitudinal Redundancy Check (LRC) character. If either type error is detected, the response to the Channel will be the character NAK.

The Display Control also monitors for character parity errors in Memory at all other times. If an error is detected, the character in error is changed to ASCII 7/15 and displayed as the rectangular error symbol. The detection of this character in the text, as it is transferred through the Interface during a READ sequence, is used to append a CAN (=ASCII-8) character to the end of the text as a flag to the Channel. Two slightly different types of detection are available by option selection. (See Appendix A - Option 9.)

5.3 CHARACTER CODES AND FORMATS

The character coding generally follows the revised ASCII set with a few exceptions in the Control Characters and Graphic Characters and is compatible with the IBM 2260/2848 code set. (See Table 5-1.)

Some of the control characters in Columns 1 and 2 provide additional functional features which will be explained later in this document. There are 63 displayable characters, plus a space, in Columns 2 through 7. Columns 6 and 7, which in the ASCII set are lower case and some additional graphic characters, duplicate Columns 4 and 5, respectively, with one exception: 4/0 is displayed as a space and 6/0 is displayed as @.

Table 5-1. SD 1110 Code Set

b7					0	0	0	0	1	1	1	1
b6					0	0	1	1	0	0	1	1
b5					0	1	0	1	0	1	0	1
				col								
b4	b3	b2	b1	row	0	1	2	3	4	5	6	7
0	0	0	0	0			SP	0	NS	P	@	P
0	0	0	1	1	SOH	CF #	!	1	A	Q	A	Q
0	0	1	0	2	STX		"	2	B	R	B	R
0	0	1	1	3	ETX		#	3	C	S	C	S
0	1	0	0	4	EOT		\$	4	D	T	D	T
0	1	0	1	5		NAK	%	5	E	U	E	U
0	1	1	0	6	ACK	See Note 4	&	6	F	V	F	V
0	1	1	1	7		ETB	'	7	G	W	G	W
1	0	0	0	8		CAN	(8	H	X	H	X
1	0	0	1	9		STP [)	9	I	Y	I	Y
1	0	1	0	10	LF		*	:	J	Z	J	Z
1	0	1	1	11		EP]	+	;	K	[K	[
1	1	0	0	12	GNS		,	<	L	L	L	L
1	1	0	1	13			-	=	M]	M]
1	1	1	0	14			.	>	N	↑	N	↑
1	1	1	1	15			/	?	O	■	O	■

Notes:

- Codes in Columns 2 through 7 are displayed as shown when in text position except 4/0 which is displayed as a blank in Open Format mode and a period in Closed Format mode.
- CF, STP, and EP, when in text, are displayed as the symbol illustrated after the character mnemonic.
- Codes marked **X** in Columns 0 and 1, when in text, are undefined, although they generally will be displayed as corresponding characters in Columns 2 and 3 respectively. They may be assigned additional control functions in the future.
- Code 1/6 in text will cause a screen erase and data will be lost.

5.3.1 Graphic Characters

These characters are displayable on the CRT screen. Any of them can be stored in the delay line Memory from the Processor by placing them in text positions. Only those indicated can be stored from the Keyboard.

Table 5-2. Text Library Characters and Codes

<u>Character Name</u>	<u>Symbol On CRT</u>	<u>Equivalent ASCII Symbol</u>	<u>Code</u>	<u>Keyboard Marking</u>
A-Z	A-Z	A-Z	ASCII	A-Z
0-9	0-9	0-9	ASCII	0-9
Space	Blank	SP	2/0	(Space Bar)
Exclamation Point	!	!	2/1	! (sc)
Quotation Marks	"	"	2/2	" (sc)
Number Sign	#	#	2/3	# (sc)
Dollar Sign	\$	\$	2/4	\$ (sc)
Percent	%	%	2/5	% (sc)
Ampersand	&	&	2/6	& (sc)
Apostrophe	'	'	2/7	' (sc)
Opening Parenthesis	((2/8	((sc)
Closing Parenthesis))	2/9) (sc)
Asterisk	*	*	2/10	* (sc)
Plus	+	+	2/11	+ (sc)
Comma	,	,	2/12	, (sc)
Hyphen (minus)	-	-	2/13	-
Period	.	.	2/14	.
Slant	/	/	2/15	/
Colon	:	:	3/10	:
Message Incomplete	;	;	3/11	;

Table 5-2. Text Library Characters and Codes (cont)

Character Name	Symbol On CRT	Equivalent ASCII Symbol	Code	Keyboard Marking
Less Than	<	<	3/12	< (sc)
Equals	=	=	3/13	= (sc)
Greater Than	>	>	3/14	> (sc)
Question Mark	?	?	3/15	? (sc)
Nonsignificant Space (See Note 2)	. (or SP)	\	6/0	(NOK)
Opening Bracket	[[5/11	[(sc)
Not Equal To	≠	~	5/12	≠ (sc)
Closing Bracket]]	5/13] (sc)
Up Arrow	↑	^	5/14	(sc)
Block (See Note 3)	■	-	5/15	(NOK)
Commercial At	@	@	4/0	@ (sc)

NOTES:

1. (NOK) - Character not on keyboard.
(sc) - Require use of SHIFT key.
2. Nonsignificant Space is displayed as a "period" only in CF mode. It is displayed as a space in OF and VF modes.
3. The Block Symbol is also used as an error character (BLOCK) using code (7/15) and the cursor.
4. Alternate codes for columns 4 and 5 are not listed. These are columns 6 and 7 codes respectively, except 6/0 is not an alternate for 4/0.

5.3.2 Format Effectors

Characters from this group are used in text positions to control display format. Their function will be as described below only when they are in correct text positions. They are stored in the display Memory (except for GNS XX) and may or may not be read, depending upon the type of READ action.

Table 5-3. Format Effectors

<u>Character</u>	<u>Function</u>	<u>Symbol On CRT</u>	<u>Equiv. ASCII Symbol</u>	<u>Code ASCII</u>	<u>Keyboard Marking</u>
CF	Closed Format	#	DC	1/1	(NOK)
STP	Start Protect	[EM	1/9	(NOK)
EP	End Protect]	ESC	1/11	(NOK)
NS	Nonsig Space	.	\	6/0	(NOK)
LF	Line Feed and Carriage Return		LF	0/10	RETURN OR CR
GNS XX	Generate NS	(CND)	FF	0/12	(NOK)

NOTES:

1. (CND) = Character not displayed.
2. (NOK) = Character not on Keyboard.
3. GNS must be followed by two decimal digits (XX) which designate the number of NS characters to be generated and stored in Memory by the Display Control. GNS XX is not stored in Memory.

5.3.2.1 Closed Format (CF)

This character is correctly used only when it is the first character of the entire display, which is the first character stored in the Memory. It will be displayed as a number

sign (#). When in first character position, the CF character puts the entire display in a Closed Format mode. This character can be stored in Memory only from the Channel, and it should be written only with an EW sequence. The CF character will be read by both the RM and Poll sequences.

5.3.2.2 Start Protect (STP), End Protect (EP)

The STP and EP characters can be entered into Memory only from the Channel and should always be used in pairs with STP first. All data displayed from the STP to the EP character is protected by the Display Control from Keyboard modification. This is accomplished by preventing the Cursor from locating on these characters. STP and EP should be separated by at least one character other than LF, and a display should not end with an EP character. They can be used in CF mode where they define the fixed fields or, when not used in CF mode, they define the VF mode and provide protected areas. They will both be read by an RM sequence, but only the STP will be read in a Poll sequence.

5.3.2.3 Nonsignificant Space (NS)

This character is intended mainly for use in CF mode, where it is displayed as a period (.) and defines the variable field. It can be entered only by the Channel and will always replace any variable field characters cleared or deleted in CF mode. It will be displayed as a blank in the VF and OF mode. It can be read only by the RM sequence in all display modes.

5.3.2.4 Line Feed (LF)

This character can be entered either by the Channel, the Keyboard or the Display Control and has the combined effect of carriage return and line feed. If not present in the WT message, it will be automatically inserted by the Display Control after 80 characters.

It will be read by both RM and Poll sequences with one exception: it will not be read by the Poll sequence when it occurs in a protected area or fixed field.

5.3.2.5 Generate XX Nonsignificant Spaces (GNS XX)

The special significance of this character is only effective in CF mode. The character GNS can only be entered from the Channel and must be followed by two decimal digits indicating the number (00 to 99) of NS's to be generated. Any number of GNS XX combinations can be written in sequence within the limits of the Memory capacity for the NS's generated. If GNS XX is written in VF or OF mode, the characters displayed will be ,XX. GNS XX is not stored as such in the delay line Memory and therefore cannot be read by either READ sequence although the generated NS's will be read by the RM sequence.

5.3.3 Control Characters

These characters are used to control the sequences between the Channel and the Terminal. They are not displayed and they are not on the Keyboard. Their interpretation is compatible with and essentially the same as that which applies to the IBM 2848/2260 Display Complex.

<u>Character</u>	<u>Code ASCII</u>
SOH	0/1
STX	0/2
ETX	0/3
EOT	0/4
ACK	0/6
CAN	1/8
NAK	1/5

5.3.4 Program Controlled Display Modes

The three modes of operation are under program control. These are (1) Open Format, (2) Closed Format, and (3) Variable Format.

- Open Format (OF) mode is established by the Channel and the Keyboard. This is the only mode which can be established from the Keyboard.
- The Closed Format (CF) mode is established only by the Channel using the CF character as the first character in Memory.
- Variable Format (VF) mode is established only by the Channel using STP and EP characters at least once in the message but not the CF character.

Up to this point, the functional descriptions have been applicable only to OF mode. Where functional differences in other modes existed, a partial explanation was sometimes presented. The following two paragraphs will now provide more complete detail on these functional differences.

5.3.4.1 Closed Format Mode

The CF mode divides the screen (and Memory) into fixed fields and variable fields and provides a method of limiting the size and location of any Keyboard entry. The fixed fields, bracketed by STP and EP characters, are fixed in location, and are protected against modification from the Keyboard. The variable fields are defined in size and location by the Processor, but their content can be modified from the Keyboard. Data, in variable fields only, can be entered, erased and otherwise modified as in OF mode by the use of the edit features of the Keyboard.

The CF mode is intended to facilitate repetitive entries into a specific fixed format. The format must be written only once and will thereafter be protected from unintentional Keyboard erasure or modification. The CF mode also permits reading only the data actually entered from the Keyboard into the variable fields of the format. The result of these two features reduces communications to and from the Terminal to a minimum.

The CF mode display is written with the EW sequence. The first character must be CF followed by the desired arrangement of fixed and variable fields. A fixed field begins with STP and ends with EP, while a variable field is defined by writing any

Text Library characters or NS. Usually the variable fields are defined by NS characters. After the variable fields are cleared, either from the Keyboard (RESET key) or by positive acknowledgment from the Channel, all variable characters are replaced with NS. Library characters can, however, be written into the variable fields initially if desired. This permits the screen to initially appear as an example of the filled-in form which would be cleared (RESET key) when the operator is ready to begin making variable field entries from the Keyboard. It can also be used to write a retrieval of a filled-in form.

The following is an example of a CF display and how it appears as an EW text character sequence.

TEXT CHARACTER SEQUENCE

```
CF LF STP N A M E EP GNS 2 5 LF STP P H O N E EP GNS 14
```

DISPLAY

```
#
[NAME] . . . . .
[PHONE] . . . . . <
```

The symbol (<) is added by the Display Control to signify the End of Displayed Text (EDT) on the screen. It is not stored in Memory and is not read in either READ sequence.

The following is an example of how Keyboard entered data is displayed and the corresponding text format read by a Poll sequence.

DISPLAY

```
#
[NAME] JONES A B. . . . .
[PHONE] 714 323 6742 . <
```

TEXT CHARACTER SEQUENCE

```
CF LF STP J O N E S SP A SP B LF STP 7 1 4 SP 3 2 3 SP 6 7 4 2
```

Simple rules for programming CF mode should be observed. Violation of a single rule, or even several, may not cause any problems; however, adherence is recommended to avoid the need to make a special test of each specific form. CF mode programming rules are as follows:

- Write CF messages with EW command only.
- CF must always be the first character.
- Use STP and EP in pairs with STP first.
- Separate STP and EP characters by at least one character other than LF.
- No single fixed field should exceed 350 characters in length.
- The message must not end with an LF or EP character.

The Cursor motion in CF mode is somewhat modified from that previously described (applying to OF mode). These differences are as follows:

- The Cursor cannot be positioned over the CF, STP, EP, LF or < (the one at EDT) characters or within the fixed fields.
- Within a variable field, the Cursor cannot be positioned on an NS other than the first NS.
- Insert will not expand the text beyond the variable field in which the Cursor is located.
- If the Cursor is on the first NS, the Right key will move the Cursor to the first NS in the next variable field.
- The Left key will not cause the Cursor to jump back across a fixed field.
- The Up key will not move the Cursor up if the line preceding contains no character on which the Cursor can be positioned.
- The Diagonal key will move the cursor to the Last Legal Position (LLP) in displayed text on which the Cursor will locate, and when combined with the CTRL key, it will move the Cursor to the First Legal Position (FLP) on which the Cursor can locate.

The Poll sequence is executed differently by the Display Control in that the entire Memory is always read. Protected characters, the character EP, and the character NS are inhibited. The RM sequence is the same in that all characters are read.

5.3.4.2 Variable Format Mode

The VF mode divides the screen into protected areas and nonprotected areas. It fixes the content but not the location of the protected areas. The nonprotected areas are not limited in size or location as they are in CF mode. They are expanded and contracted by Keyboard action, and the protected areas defined by the STP and EP characters will move accordingly.

The rules for writing in VF mode are identical to those for CF mode except that the CF character is not used.

Both the RM and the Poll sequences follow the same rules as OF mode with respect to control of the UM and LM. The Cursor motion follows the same rules as in CF mode except that NS is treated the same as any other data character.

Partial mode is needed if it is desired to use a Poll sequence to read the text previously written by the Processor. If Partial mode is used to read the whole Memory, the STP characters act as field separators in a Poll response, just as they do in the CF mode, i.e., the protected data and the EP character are not read. Nonsignificant spaces are not normally used. If they are used, the NS character displays as a Space and is read only in the RM sequence. In addition, GNS is not effective in VF mode.

5.4 SEQUENCES AND RESPONSES

The communications operates in full duplex mode to minimize turnaround time although the Terminals and the Channel effectively communicate in half duplex sequences. Figures 5-1 through 5-6 and the notes following each, describe the four sequences: two READ and two WRITE, that can be executed by the SD 1110/360R Terminals. The addresses, Command codes, and Control Characters are 7 bit structures similar to ASCII and the same as those used with the IBM 2701/2848 configuration.

These codes and the ASCII data codes are actually converted to and from ASCII-8 in the 2701 since the System/360 uses an 8-bit structure rather than the 7-bit structure of ASCII. The heavy lines in the diagrams trace the major no-error paths that are recommended for most efficient use of the SD 1110/360R Terminals. The sequences are also the same in structure as those used with the IBM 2701/2848. The character SOH can be substituted for EOT since their effect is identical.

**CHANNEL SEQUENCES
AND RESPONSES**

**SD1110
TERMINAL SEQUENCES
AND RESPONSES**

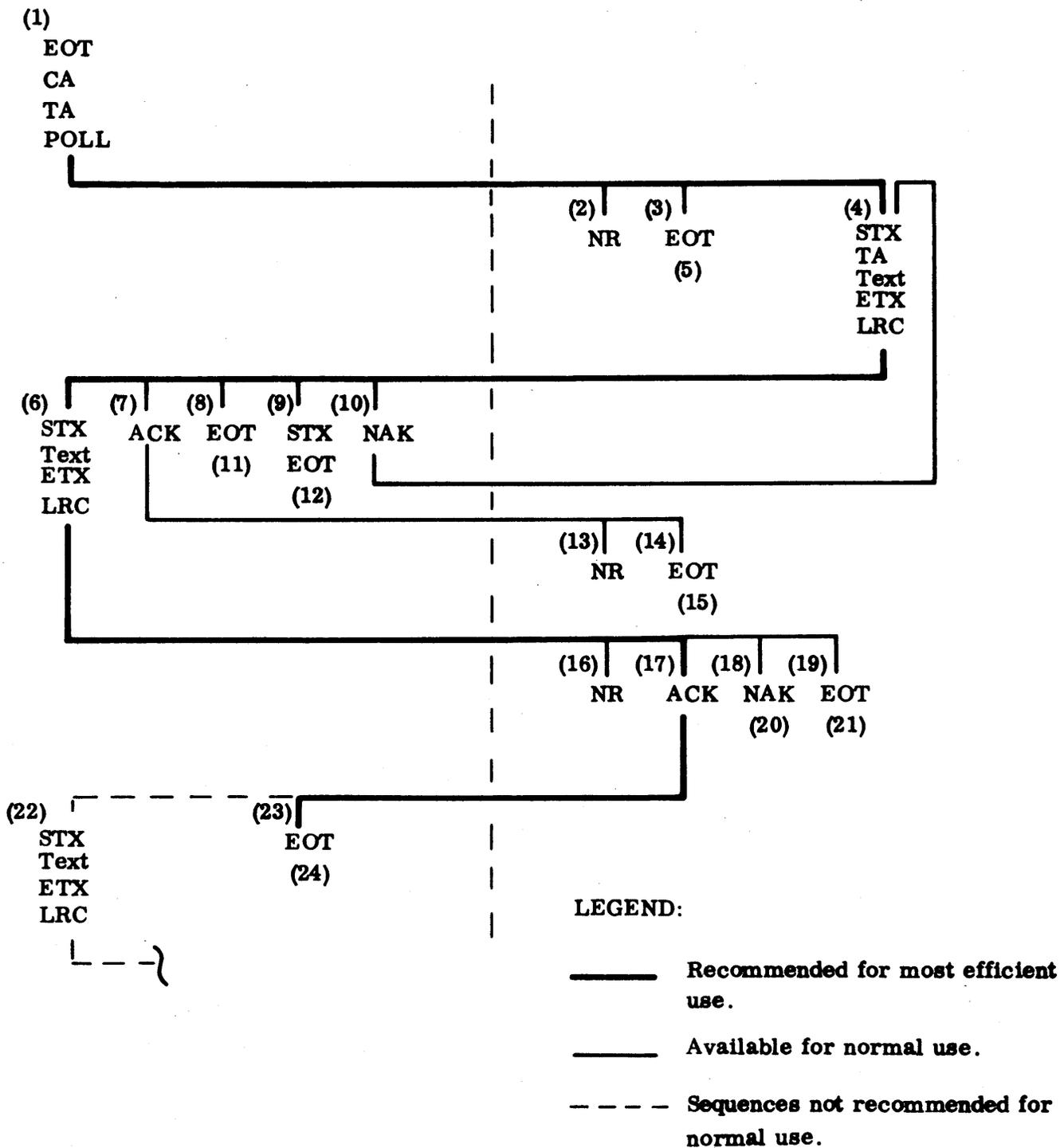

Figure 5-1. Sequence/Response Diagram - Specific Poll- OF or VF Mode

NOTES FOR SEQUENCE/RESPONSE DIAGRAM - SPECIFIC POLL - OF or VF MODES

1. Addressing sequence. Selects Terminal and issues Command.
2. No response. Equipment or communications fault indicated.
3. No traffic. XMIT key not depressed.
4. XMIT key has been depressed. Keyboard is locked. Reads from UM to LM.
5. Terminates selection of Terminal. No effect on display or keyboard.
6. Affirmative response with text Sequence to be added to display. Markers (UM and LM) not yet moved at this point.
7. Affirmative response. Intended for a group of terminals on a Multiple Terminal controller. Markers not moved. STX EOT response is faster and preferred with this Terminal.
8. Negative termination after several repeats are unsuccessful.
9. Affirmative termination.
10. Negative response. Used when repeat of terminal transmission is desired.
11. Keyboard locked. LM and UM not moved.
12. Keyboard locked. UM moved to LM.
13. No response. Equipment or communications fault indicated.
14. Normal termination.
15. Keyboard locked. LM and UM not moved.
16. No response. Equipment or communications fault indicated.
17. Affirmative response. Keyboard unlocked.
18. Negative termination. Parity or LRC error detected.
19. Negative termination. Data loss due to Memory overflow.
20. Keyboard unlocked. LM and UM will be in same position as UM at 4.
21. Keyboard unlocked. LM repositioned to SDT (FLP in VF mode). UM in same position as at 4.
22. Continue writing.
23. Normal termination.
24. Keyboard unlocked. UM and LM at EDT or Last Legal Position (LLP) before EDT.

**CHANNEL SEQUENCES
AND RESPONSES**

**SD1110
TERMINAL SEQUENCES
AND RESPONSES**

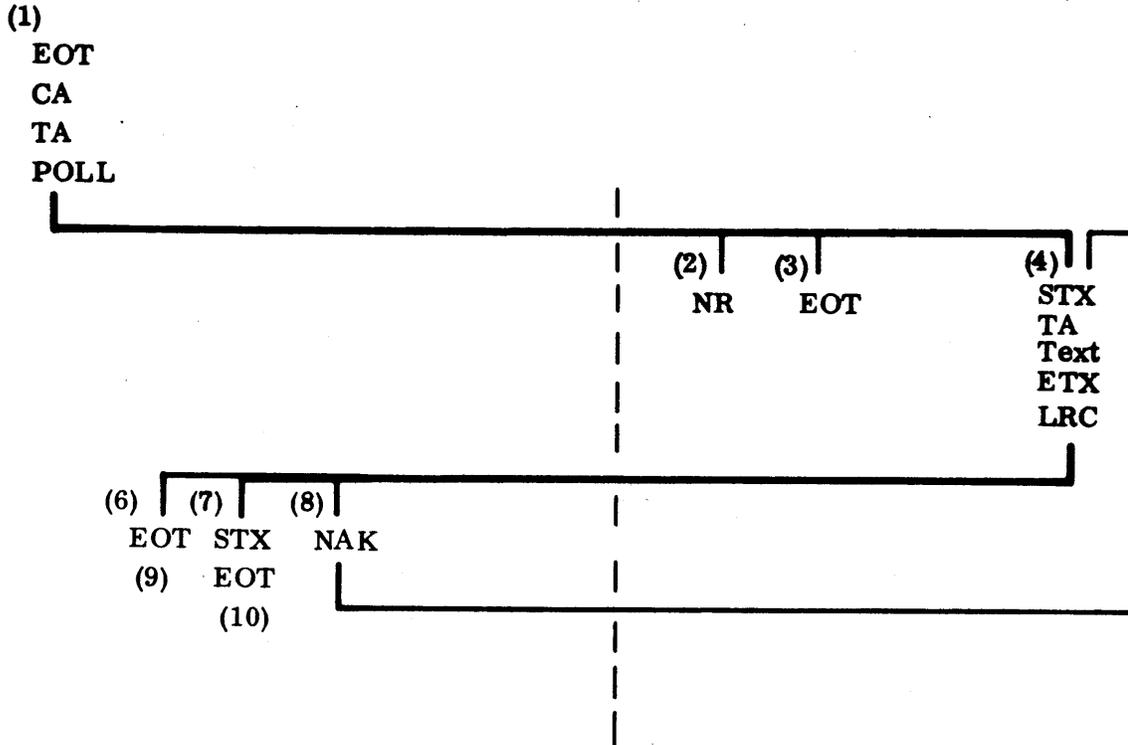

LEGEND:

———— Recommended for most efficient use.

----- Available for normal use.

Figure 5-2. Sequence/Response Diagram - Specific Poll - CF Mode

NOTES FOR SEQUENCE/RESPONSE DIAGRAM-SPECIFIC POLL - CF MODES

1. Addressing sequence. Selects Terminal and issues Command.
2. No response. Equipment or communications fault indicated.
3. No traffic. XMIT key is not depressed.
4. XMIT key has been depressed. Keyboard is locked. Reads CF and STP characters and variable fields.
5. Terminates selection of Terminal. No effect on display or Keyboard.
6. Negative termination after several repeats are unsuccessful.
7. Affirmative termination.
8. Negative response used when repeat of terminal transmission is desired.
9. Keyboard locked. Does not clear variable fields.
10. Keyboard unlocked. LM moved to LFP. Clears variable fields.

**CHANNEL SEQUENCES
AND RESPONSES**

**SD1110
TERMINAL SEQUENCES
AND RESPONSES**

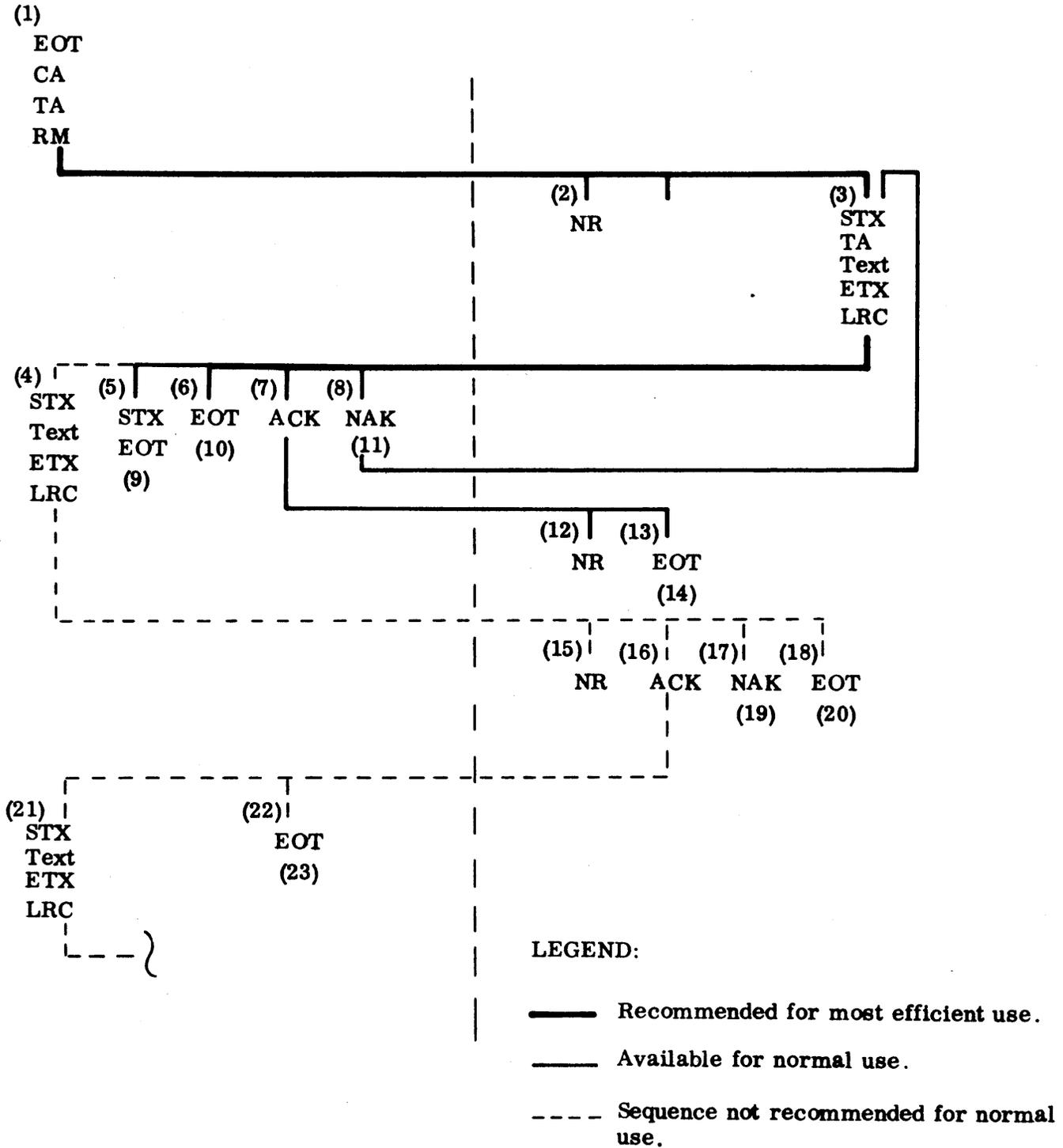

Figure 5-3. Sequence/Response Diagram - Read Memory - OF and VF Modes

NOTES FOR SEQUENCE/RESPONSE DIAGRAM - READ MEMORY - OF AND VF MODES

1. Addressing sequence. Selects Terminal and issues Command.
2. No response. Equipment or communications fault, except normal if RO is up (XMIT key has been depressed). A Poll will clear RO and permit a subsequent RM response.
3. Normal response. Reads entire Memory. Keyboard locked only during actual Readout.
4. Affirmative response with text to be added to the display in the same sequence. This is not a recommended sequence because the loading of the added text will begin at the current position of the LM. If editing action was in process, the Cursor may be located in displayed text and the message to be added would "write over" data following the Cursor.
5. Affirmative termination. Use with caution because UM will be moved to LM.
6. Affirmative termination. Preferred over (7) because it is faster.
7. Affirmative response. Use of (6) is faster.
8. Negative response. Used when repeat of terminal transmission is desired.
9. UM moved to LM. Keyboard remains unlocked.
10. LM and UM not moved. Display not modified.
11. Returns to (3).
12. No response. Equipment or communications fault indicated.
13. Normal termination.
14. LM and UM not moved. Display not modified.
15. No response. Equipment or communications fault indicated.
16. Affirmative response.
17. Negative termination. LRC or parity error detected.
18. Negative termination. Lost data due to Memory overflow.
19. LM is moved to UM.
20. LM is moved to SDT or the First Legal Position (FLP) after SDT.
21. LM and UM will be repositioned to EDT or LLP and writing will continue.
22. Normal termination.
23. LM and UM will be moved to EDT or LLP.

**CHANNEL SEQUENCES
AND RESPONSES**

**SD1110
TERMINAL SEQUENCES
AND RESPONSES**

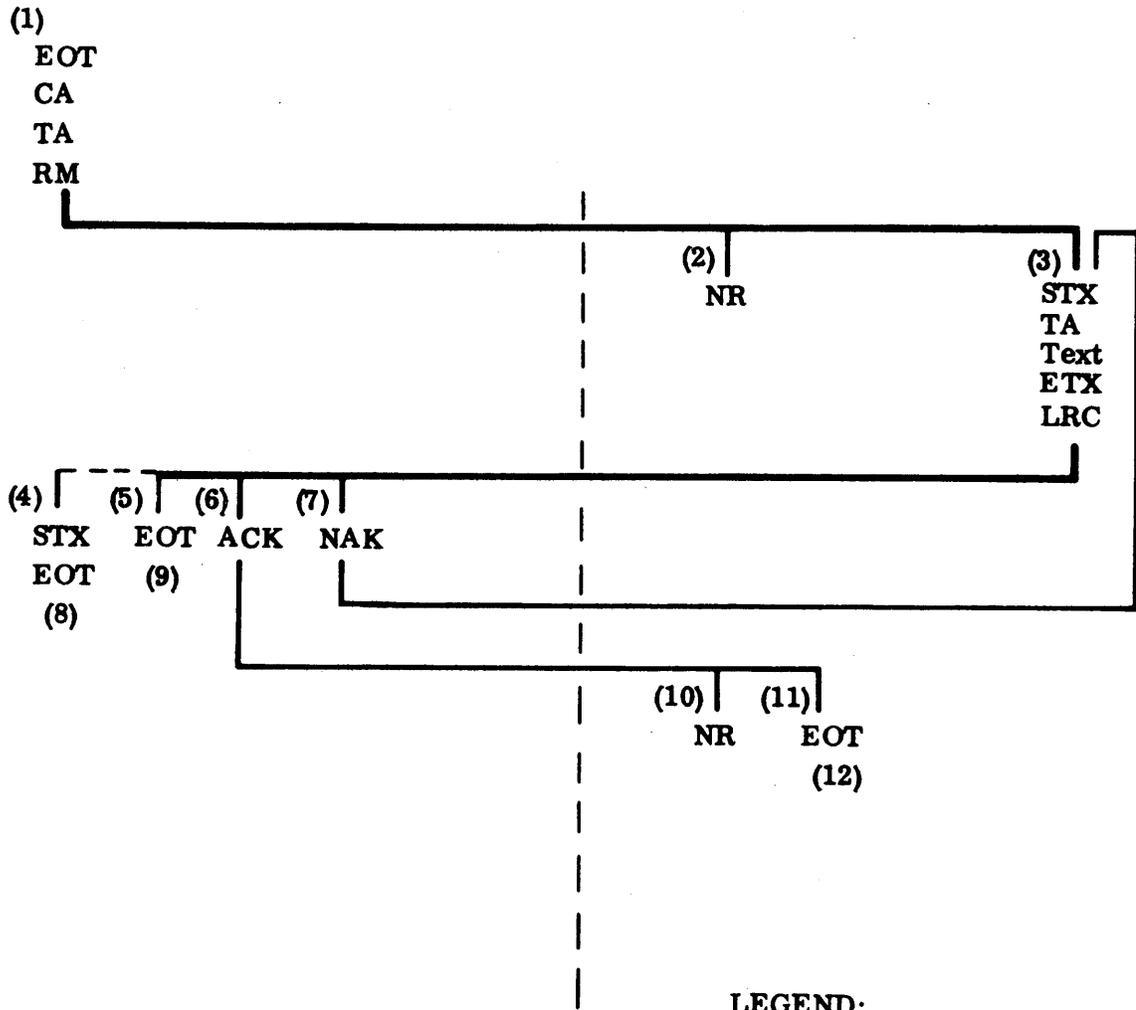

LEGEND:

- Recommended for most efficient use.
- Available for normal use.
- Sequence not recommended for normal use.

Figure 5-4. Sequence/Response Diagram - Read Memory - CF Mode

NOTES FOR SEQUENCE/RESPONSE DIAGRAM - READ MEMORY - CF MODE

1. Addressing sequence. Selects terminal and issues Command.
2. No response. Equipment or communications fault except normal if RO is up (XMIT has been depressed). A Poll will clear RO and permit a subsequent RM response.
3. Normal response. Reads entire Memory. Keyboard locked only during actual Read response.
4. Affirmative termination. Use with caution because variable fields will be cleared.
5. Affirmative termination. Preferred over (6) because it is faster.
6. Affirmative response. (5) is faster.
7. Negative response. Used when repeat of Read response is desired.
8. LM at FLP. Variable fields cleared.
9. LM not moved. Variable fields not cleared.
10. No response. Equipment or communications fault.
11. Normal termination.
12. LM moved to FLP. Variable fields not cleared.

**CHANNEL SEQUENCES
AND RESPONSES**

**SD1110
TERMINAL SEQUENCES
AND RESPONSES**

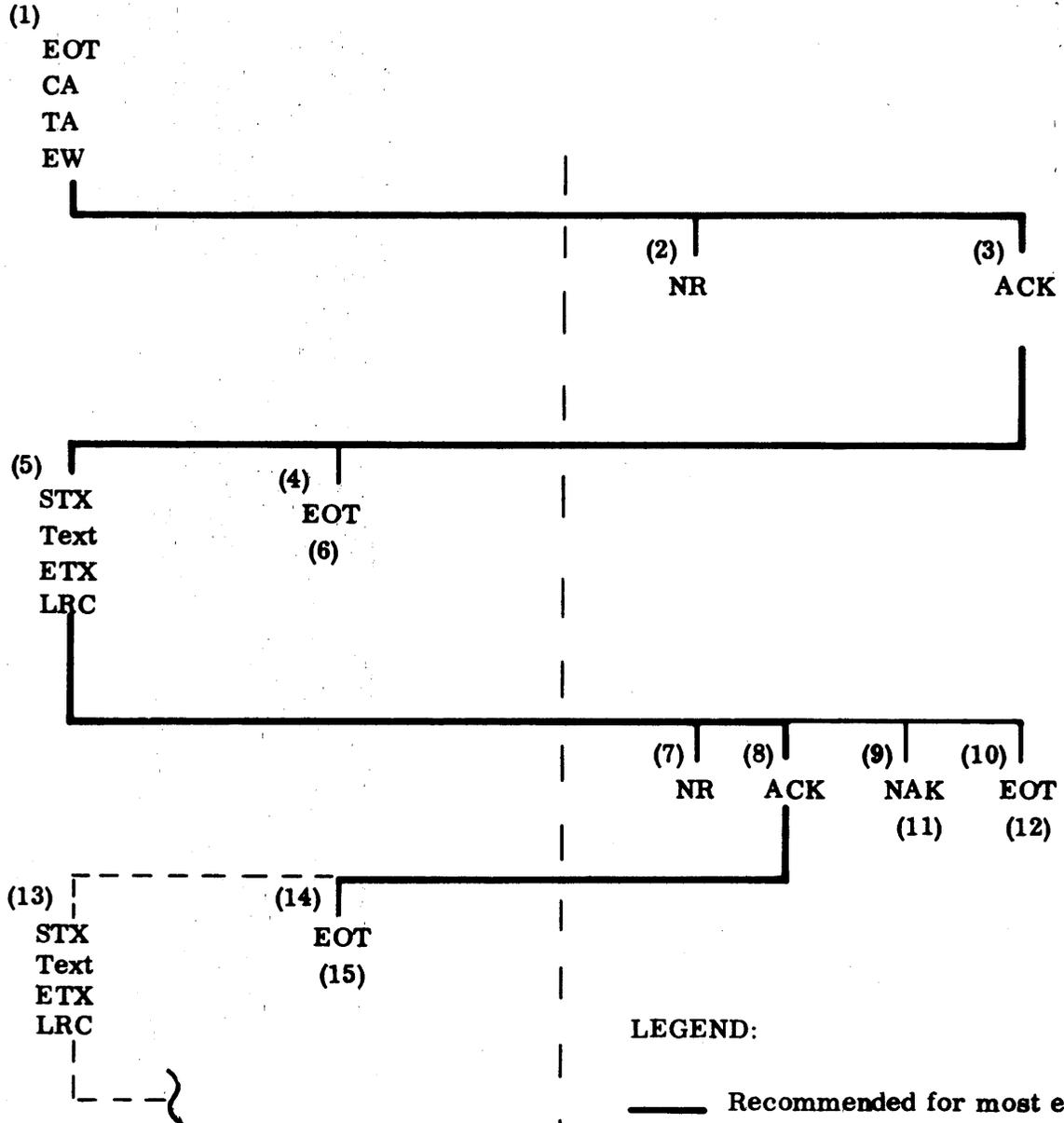

Figure 5-5. Sequence/Response Diagram - Erase/Write - All Modes

NOTES FOR SEQUENCE/RESPONSE DIAGRAM - ERASE/WRITE - ALL MODES

1. Addressing sequence. Selects Terminal and issues Command.
2. No response. Equipment or communications fault except normal if EW message occurs when RO is up (XMIT has been depressed). The Terminal must first be Polled to clear the RO condition if unsolicited messages are to be used.
3. Normal "Ready" response.
4. Termination (abort).
5. Normal message sequence.
6. Display is erased.
7. No response. Equipment or communications fault indicated.
8. Affirmative response. No parity or LRC error detected.
9. Negative termination. Parity or LRC error detected.
10. Negative termination. Loss of data detected due to Memory overflow.
11. LM and UM at SDT or FLP.
12. LM and UM at SDT or FLP.
13. Continue writing. Use with caution because the Keyboard is unlocked between 8 and 13 permitting possible undesired entries.
14. Normal termination.
15. UM and LM at EDT or LLP.

CHANNEL SEQUENCES
AND RESPONSES

SD1110
TERMINAL SEQUENCES
AND RESPONSES

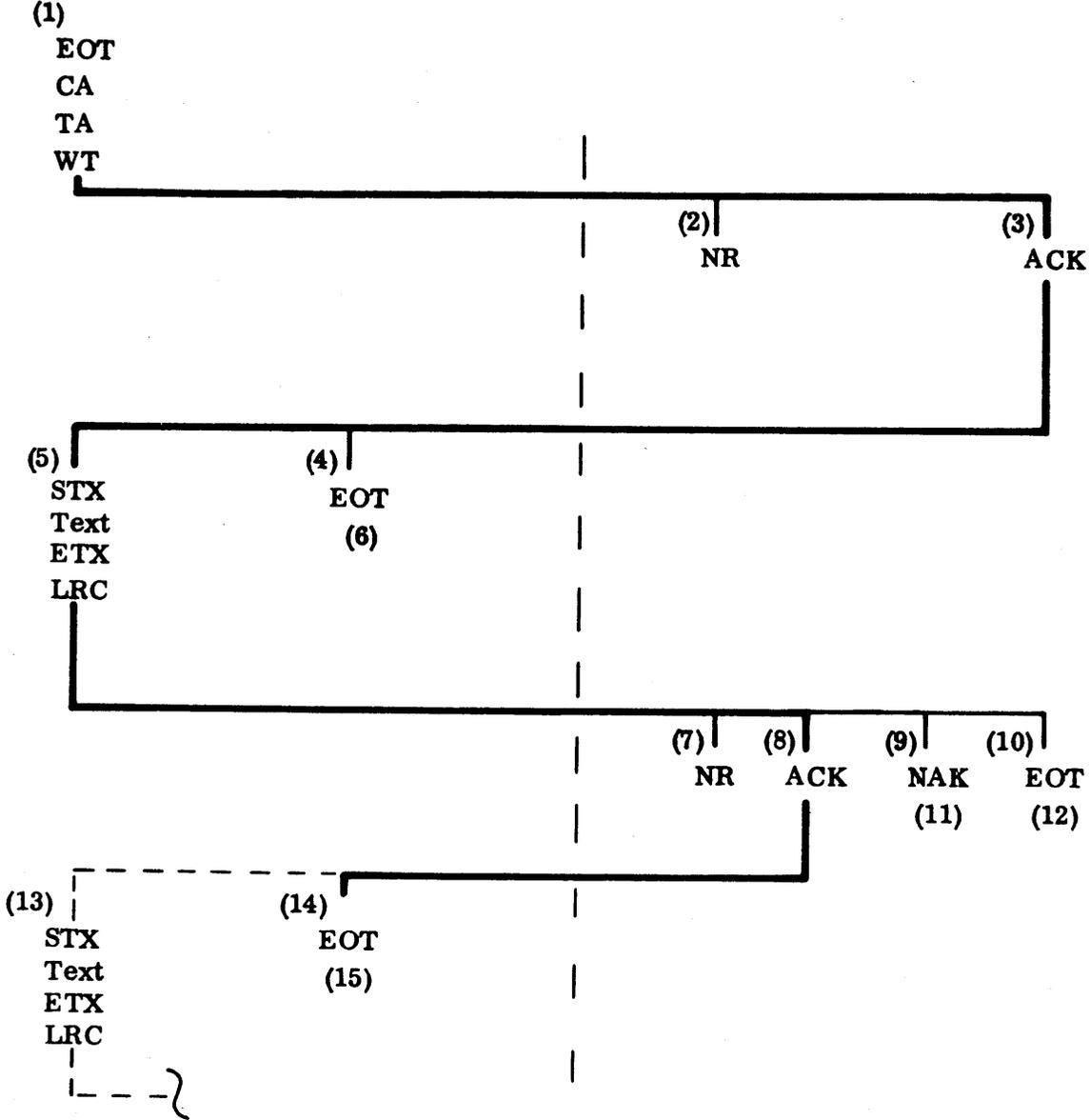

LEGEND:

———— Recommended for most efficient use.

———— Available for normal use.

----- Sequences not recommended for normal use.

Figure 5-6. Sequence/Response Diagram - Write - OF Mode Only

NOTES FOR SEQUENCE/RESPONSE DIAGRAM - WRITE - OF MODE ONLY

1. Addressing sequence. Selects Terminal and issues Command.
2. No response. Equipment or communications fault except normal if WT message occurs when RO is up (XMIT has been depressed). The Terminal must first be Polled to clear the RO condition if unsolicited messages are to be used.
3. Normal "Ready" response.
4. Termination (abort).
5. Normal message sequence.
6. Display and markers will be unchanged.
7. No response. Equipment or communications fault indicated.
8. Affirmative response. No parity or LRC error detected.
9. Negative termination. Parity or LRC error detected.
10. Termination. Loss of data detected due to Memory overflow.
11. LM is moved to UM.
12. LM to SDT. UM not moved.
13. Continue writing. Use with caution because the Keyboard is unlocked between 8 and 13 permitting possible undesired entries.
14. Normal termination.
15. UM and LM at EDT.

5.4.1 Common Sequence Summary

Tables 5-4 and 5-5 summarize the most significant Terminal conditions in the most common sequences. These summaries should be useful in planning task programs where it is necessary to have precise knowledge of the locations of the UM and LM, the Keyboard locking, and control of the clearing of the RO and variable fields.

Table 5-4. Common Read Sequences

CMD	CHANNEL RESPONSE	MODE	FINAL CONDITIONS					COMMENTS
			KBD	LM	UM	VAR	NOTE 4	
RM	STX EOT	OF	U	NM	LM	N/A	S	Relocation of markers UM and LM will generally be undesirable.
		VF	U	NM	LM	N/A	S	
		CF	U	FLP	SDT	CL	S	
	ACK	OF	U	NM	NM	N/A	Δ	Affirmative response--Display is not modified.
		VF	U	NM	NM	N/A	Δ	
		CF	U	NM	SDT	NC	▲	
	EOT	OF	U	NM	NM	N/A	▲	Affirmative termination--Display is not modified.
		VF	U	NM	NM	N/A	▲	
		CF	U	NM	SDT	NC	▲	
	STX Text ETX LRC	OF	U	EDT	EDT	N/A	S	May write over existing display--depending on initial LM location.
		VF	U	EDT	EDT	N/A	S	
		CF	/ / / / / / / / / / / / /	X	RESULT UNSPECIFIED.			
POLL	STX EOT	OF	L	NM	LM	N/A	▲	Affirmative termination.
		VF	L	NM	LM	N/A	▲	
		CF	U	FLP	SDT	CL	▲	
	ACK	OF	L	NM	NM	N/A	Δ	Affirmative response.
		VF	L	NM	NM	N/A	Δ	
		CF	L	FLP	SDT	NC	X	
	EOT	OF	L	NM	NM	N/A	▲	Negative termination.
		VF	L	NM	NM	N/A	▲	
		CF	L	LLP	SDT	NC	▲	
	STX Text ETX LRC	OF	U	EDT	EDT	N/A	▲	Normal Write (add-on) response.
		VF	U	EDT	EDT	N/A	▲	
		CF	/ / / / / / / / / / / / /	X	RESULT UNSPECIFIED.			

Table 5-4. Common Read Sequences (cont.)

NOTES:

1. Assumptions.
 - A. Keyboard is unlocked and the XMIT key has not been depressed prior to the RM command.
 - B. The XMIT key has been depressed prior to the Poll command.
 - C. No parity or LRC error is detected.
2. Refer to Appendix B for definition of abbreviations.
3. All responses to Poll clear the RO condition.
4. ▲ Recommended for most efficient operation of Terminal and use of communication capacity.
△ Recommended for efficient Terminal operation but slightly wasteful of communications capacity.
S Available for special use but caution is advised because of potential undesirable action or final conditions.
X Not recommended.

Table 5-5. Common Write Sequences

CMD	TERMINAL RESP #2	MODE	FINAL CONDITIONS		COMMENTS
			LM	UM	
EW	ACK	OF	EDT	EDT	Affirmative response.
		VF	EDT	EDT	
		CF	LLP	SDT	
	NAK	OF	SDT	SDT	Negative termination. Parity or LRC error.
		VF	FLP	SDT	
		CF	LLP	SDT	
	EOT	OF	SDT	SDT	Negative termination. -Data loss at Terminal.
		VF	FLP	SDT	
		CF	LLP	SDT	
WT	ACK	OF	EDT	EDT	Affirmative response.
		VF	/ / / / / / / / / /		RESULT UNSPECIFIED.
		CF	/ / / / / / / / / /		RESULT UNSPECIFIED.
	NAK	OF	UM	NM	Negative termination.
		VF	/ / / / / / / / / /		RESULT UNSPECIFIED.
		CF	/ / / / / / / / / /		RESULT UNSPECIFIED.
	EOT	OF	SDT	NM	Negative termination. -Data loss at Terminal.
		VF	/ / / / / / / / / /		RESULT UNSPECIFIED.
		CF	/ / / / / / / / / /		RESULT UNSPECIFIED.

NOTES:

1. WT sequence is normally initiated only when terminal is in WACK condition.
2. RO will block address ACK response (terminal response Number 1) for both EW and WT.

SECTION VI

TERMINAL CONFIGURATION

The SD 1110/360R Terminal is designed to permit remote multidrop (multiple Data Set) applications, multiple terminals on a single Data Set through the SD 1110 Data Set Distributor, and local single or multiple terminals using the SD 1110 Data Set Simulator to substitute for the 201B Data Sets. The SD 1110 Terminals can also be intermixed on a single multidrop communications line with the IBM 2848/2260 Terminal Complex. Figures 6-1 through 6-4 show typical remote terminal configurations.

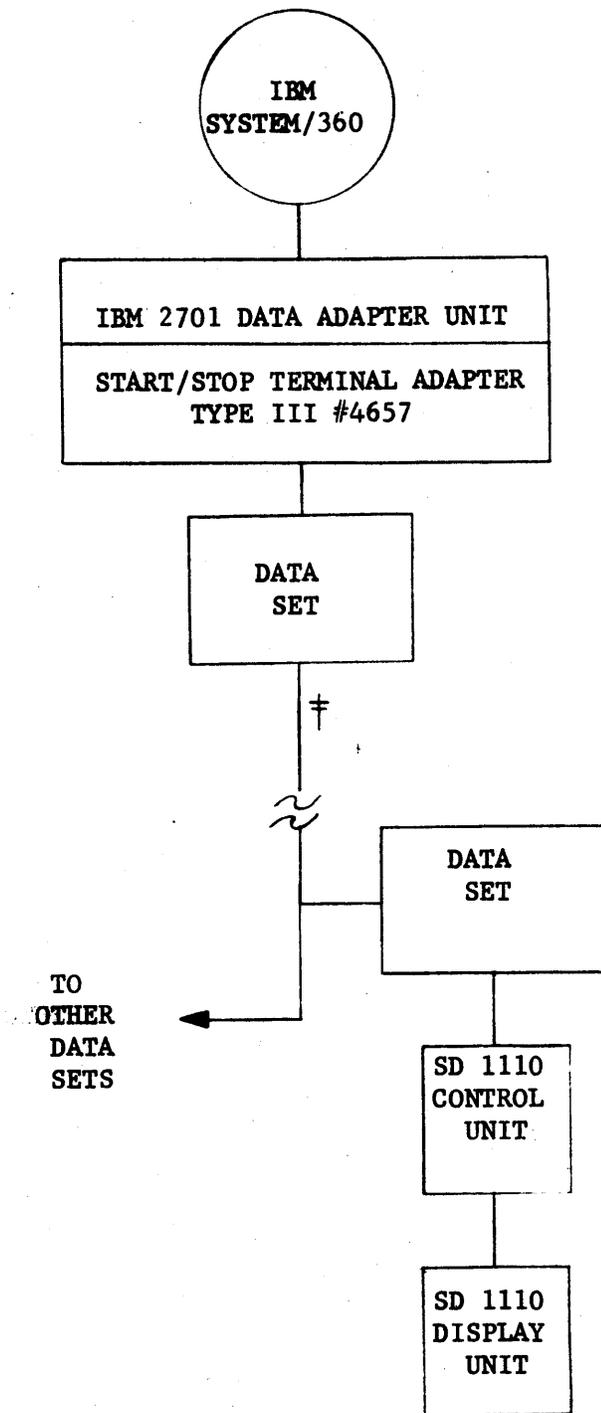

Figure 6-1. Typical Remote Single Terminal

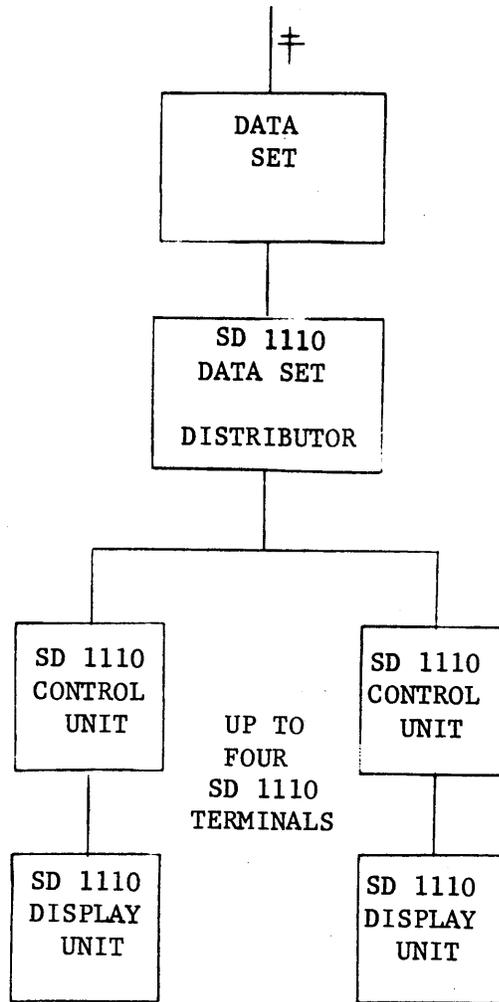

Figure 6-2. Typical Remote 2 to 4 Terminal Complex

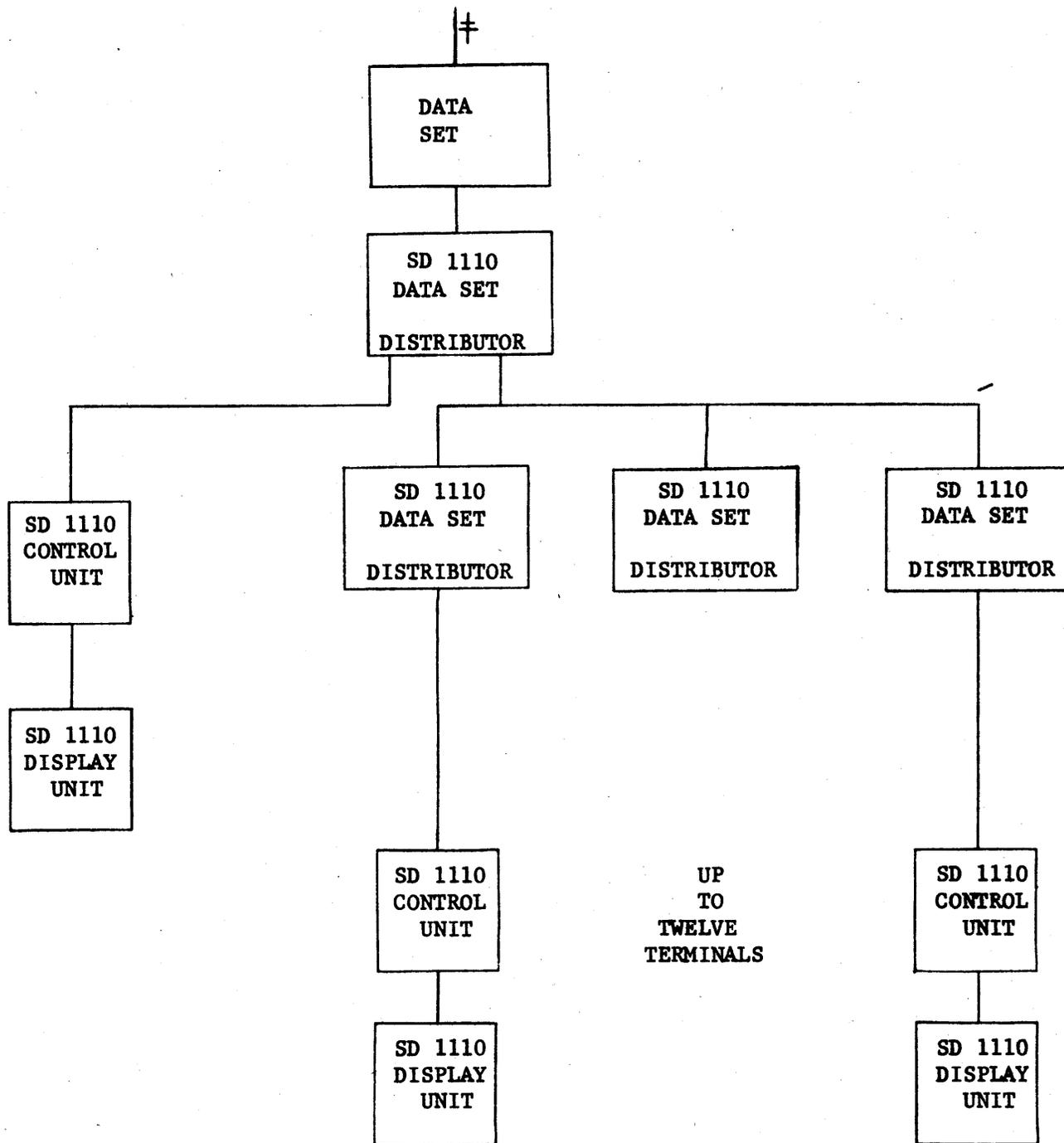

Figure 6-3. Typical Remote 5 to 13 Terminal Complex

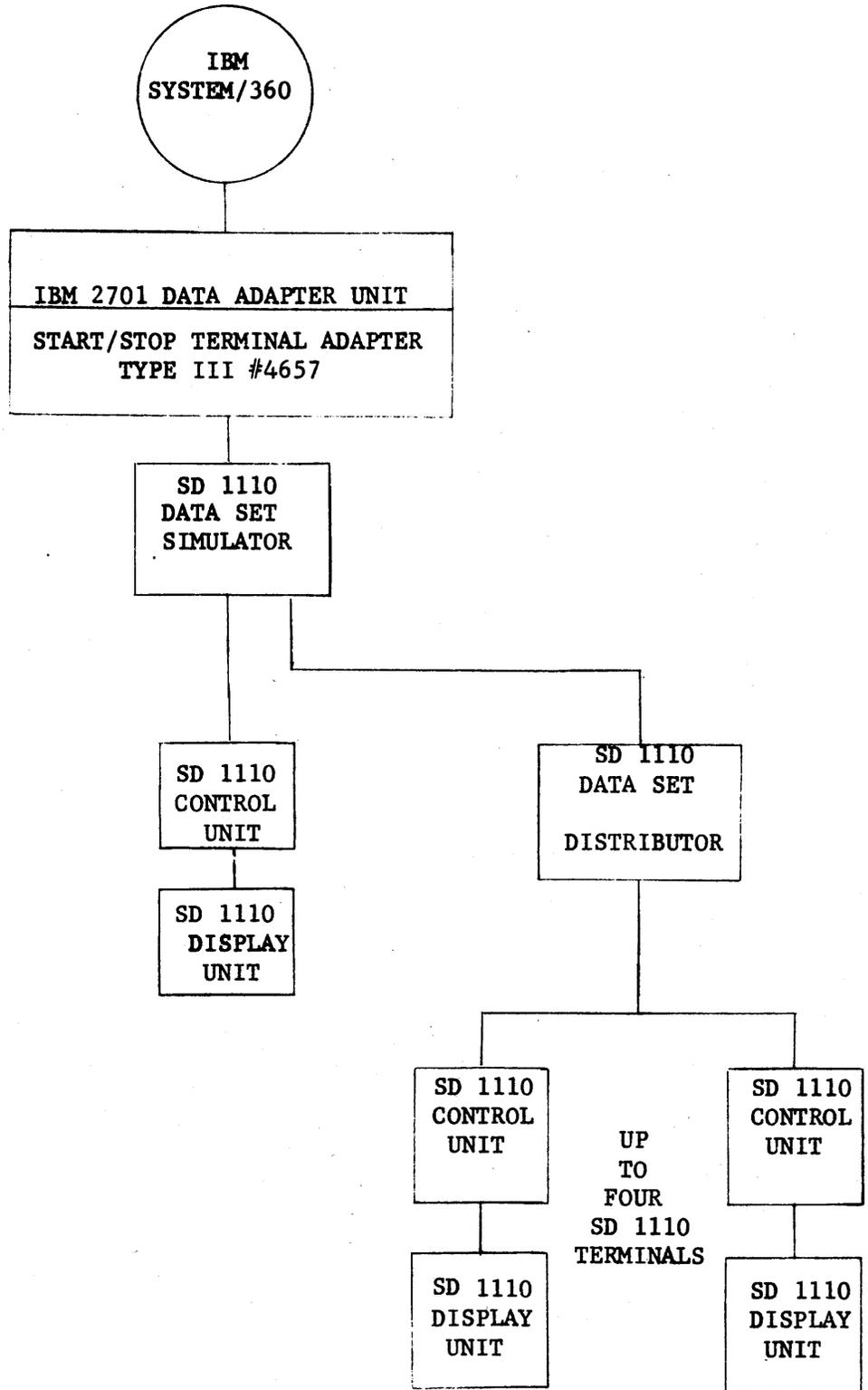

Figure 6-4. Typical Remote 3 to 5 Terminal Complex

SECTION VII

PHYSICAL DESCRIPTION

7.1 CONSTRUCTION

The CU's are ruggedly constructed with removable panels for ease of maintenance. The CU components and chassis are bolted or hinged to the frame. The DU's are contained in attractive, well styled cabinets to present a pleasing appearance and should blend in well with any installation decor. The CU is designed so that it can be used as a pedestal for the DU. However, if desired, the DU can be remotely located up to 50 feet from the CU.

7.2 DIMENSIONS AND WEIGHT

<u>Unit</u>	<u>Depth</u>	<u>Height</u>	<u>Width</u>	<u>Weight</u>
Display Unit	30"	15-1/2"	14"	70 lbs
Control Unit	30"	26"	21"	170 lbs

7.3 FINISH AND COLOR

The exterior finish of the CU is light grey, complemented by flat black exposed frame. The exterior finish of the DU's is also light grey with flat black bezels and bases.

7.4 FLOOR SPACE REQUIREMENTS

Approximately 4-1/2 square feet.

7.5 POWER REQUIREMENTS

Power Source Characteristics

- Voltage 105 - 125 Volts, single phase
- Frequency 60 Hz \pm 3 Hz

Power Consumption at 115 Volts

<u>Unit</u>	<u>Wattage</u>	<u>Power Factor</u>	<u>BTU/HR</u>
● Control Unit	250 Watts	0.8	850
● Display Unit	160 Watts	0.8	545

7.6

ENVIRONMENTAL CONDITIONS

Operative

- Ambient Temperature +55 to +100 degrees F
- Relative Humidity Up to 90 percent

Nonoperative

- Ambient Temperature 0 to 160 degrees F
- Relative Humidity Up to 100 percent

APPENDIX A

OPTION SUMMARY AND MODE SUMMARY

OPTION SUMMARY

The following options may be selected when the Terminals are ordered. Option A will be wired into the units if not otherwise specified. Options can be easily changed in the field.

1. Cursor Control in Partial Mode
 - a. The Cursor does not move when the XMIT key is depressed.
 - b. The Cursor jumps to EDT when the XMIT key is depressed.
2. ETB - Partial Mode
 - a. ETB is inserted as the first character of text in a Poll sequence when the Terminal is in Partial mode.
 - b. No ETB is inserted.
3. ETB - No Text
 - a. ETB is not inserted.
 - b. ETB is inserted as the only character of text if XMIT key has been depressed and no Keyboard entries have been made.
4. Maximum Displayed Characters per Line
 - a. 80 characters per line.
 - b. 40, 48, 51, 55, 64, 66, 68, 72, 75 characters per line.
5. Maximum Lines per Display
 - a. 36 lines.
 - b. 18, 21, 22, 25, 28, 29, 30, 32, 33, 36 lines.

6. Address
 - a. Controller Address = 101 (octal) = A1 (HEX ASCII-8).
Terminal Address = 041 (octal) = 41 (HEX ASCII-8).
 - b. Both addresses specified except:
Controller Address - Bits 7 and 6 \neq 00.
Terminal Address - Bits 7 and 6 = 10 or 01 only.
7. Slewing of Data Keys
 - a. No Data Keys slew.
 - b. Specified Data Keys slew.
8. General Poll Response
 - a. Terminal will respond to General Poll
(Terminal Address Code of all ones).
 - b. Terminal will not respond to General Poll.
9. CAN Character
 - a. Appended to text only if transfer error is detected.
 - b. Appended to text if transfer error or stored error character is detected.
10. Double Refresh Rate
 - a. 50 cycle.
 - b. 100 cycle. This will double the brightness of the display and reduce the maximum number of characters displayable to approximately 500.

MODES SUMMARY

The following modes are of major functional importance in the operation and programming of the terminal.

1. Partial

Conditions

flickering over displayed character at UM.
Cursor inhibited from jump to EDT on XMIT. (See Option 1.)
ETB first character in text. (See Option 2.)

Set

SF key (moves UM to LM).
 Partial cannot be set in CF mode.

Clear

CTRL/RESET.

RESET.

*ETX received from Channel.

*NOTE: UM and LM will relocate to EDT on receipt of
 ETX, or remain unmoved (See Option 5.)

2. InsertConditions

A character entered via the Keyboard will be inserted
 ahead of the Cursor and the text will spread.

Set

Depression of the INS Key.

Clear

Depression of any Edit Key (except INS), the XMIT key or CTRL/RESET.

3. Wait Acknowledge (WACK)Conditions

Keyboard locked - light out.

Set

Poll Read response by Terminal.

Clear

ETX received from the Channel or CTRL/RESET from keyboard,
 or RESET in CF mode only.

4. Request Out (RO)Conditions

Keyboard locked - light out.

Set

Depression of XMIT key.

Clear

Poll from Channel.
CTRL/RESET.
RESET.

5. Memory Overflow

Conditions

Response to WT message from Channel will be EOT.

Set

By an EW or WT sequence from the Channel which results in one or less remaining character positions in Memory.

Clear

EW sequence from the Channel.
CTRL/RESET.

6. Closed Format (CF)

Conditions

See Paragraph 5.3.4.1 on Closed Format.

Set

CF character received from Channel.

Clear

EW sequence from Channel without CF character in Text.
CTRL/RESET.

7. Variable Format (VF)

Conditions

See Paragraph 5.3.4.2 on Variable Format.

Set

STP and EP characters (but no CF character) received in Text from Channel.

Clear

EW sequence from Channel without STP and EP characters.
CTRL/RESET.

8. Open Format (OF)

Conditions

See Paragraph 5.3.4 on Program Controlled Display Modes.

Set

Any entry into Memory without CF, STP or EP.

Clear

Any Channel sequence which sets CF or VF mode.

9. Selected

Conditions

Data Set Carrier turned on by Interface.

Terminal will accept Channel sequences and respond appropriately.

Set

Correct addressing sequence from the Channel.

Clear

Receipt of characters EOT or SOH by the Terminal or transmission of a response of EOT or NAK by the Terminal.

APPENDIX B

ABBREVIATION AND CODE CONVERSION TABLES

Appendix B includes a summary of the abbreviations used in this document and code conversion tables. Character mnemonics in the ASCII set are not included.

ABBREVIATIONS

CA	Control Address
CF	Closed Format
CL	Cleared
CMD	Command
EDT	End of Displayed Text = 1 character position after last stored character in Memory
FLP	First Legal Position
L	Locked
lc	lower case
LLP	Last Legal Position
LM	Load Mark
NC	Not Cleared
NM	Not Moved
NR	No Response
OF	Open Format
RM	Read Memory
RO	Request Out - XMIT has been depressed
SDT	Start of Displayed Text - first stored character in Memory
TA	Terminal Address
UC	Upper Case
U	Unlocked
UM	Unload Mark
VF	Variable Format
WACK	Wait Acknowledge - Station is waiting for positive or negative acknowledgement before automatic marker relocation begins

X Not Applicable

▲ Preferred

△ Acceptable

Table B-1. Code Conversion
Octal (Even Parity ASCII) - Hex (ASCII - 8) - Character

OCTAL	HEX	CHAR	OCTAL	HEX	CHAR	OCTAL	HEX	CHAR	OCTAL	HEX	CHAR
*000	*00	SP	101	A1	A	201	01	SOH	300	A0	NS (05)
003	03	ETX	102	A2	B	202	02	STX	303	A3	C
*005	*05	%	104	A4	D	204	04	EOT	305	A5	E
006	06	ACK	107	A7	G	*207	*07	'	306	A6	F
*011	*09)	110	A8	H	*210	*08	(311	A9	I
012	0A	LF	113	AB	K	*213	*0B	+	312	AA	J
(30) 014	0C	GNS ⁽³⁾	115	AD	M	*215	*0D	-	314	AC	L
*014	*0C	, (4)	116	AE	N	*216	*0E	.	317	AF	O
(38) 021	11	CF	120	B0	P	*217	*0F	/	321	B1	Q
*022	*12	2	123	B3	S	*220	*10	0	322	B2	R
*023	*13	3	125	B5	U	225	15	NAK	324	B4	T
*024	*14	4	126	B6	V	226	16	SYN	327	B7	W
027	17	ETB	131	B9	Y	231 (18) 19	19	STP	330	B8	X
030	18	CAN	132	BA	Z	*232	*1A	:	333	BB	[
(58) 033	1B	EP	134	BC	≠	*234	*1C	<	335	BD]
*035	*1D	=	137	BF	■	*237	*1F	?	336	BE	†
*036	*1E	>	140	E0	@	240	40	SP	341	E1	a
041	41	!	143	E3	c	243	43	#	342	E2	b
042	42	"	145	E5	e	245	45	%	344	E4	d
044	44	\$	146	E6	f	246	46	&	347	E7	g
047	47	'	151	E9	i	251	49)	350	E8	h
050	48	(152	EA	j	252	4A	*	353	EB	k
053	4B	+	154	EC	l	254	4C	,	355	ED	m
055	4D	-	157	EF	o	257	4F	/	356	EE	n
056	4E	.	161	F1	q	261	51	1	360	F0	p
060	50	0	162	F2	r	262	52	2	363	F3	s
063	53	3	164	F4	t	264	54	4	365	F5	u
065	55	5	167	F7	w	267	57	7	366	F6	v
066	56	6	170	F8	x	270	58	8	371	F9	y
071	59	9	173	FB	[(1c)	273	5B	;	372	FA	z
072	5A	:	175	FD](1c)	275	5D	=	374	FC	≠(1c)
074	5C	<	176	FE	†(1c)	276	5E	>	377	FF	■(1c)
077	5F	?									

NOTES:

1. Codes marked * are reserved for control function assignment.
2. Code 026=16(HEX)=ASCII SYN must not be used in text--will cause screen erasure and loss of data.
3. Applies to Closed Format only.
4. Applies to Open Format only.

Table B-2. Code Conversion
Character - Octal (Even Parity ASCII)

CHAR	OCTAL	OCTAL (Lower Case)	CHAR	OCTAL
@	140		:	072
A	101	341	;	273
B	102	342	<	074
C	303	143	=	275
D	104	344	>	276
E	305	145	?	077
F	306	146	!	041
G	107	347	"	042
H	110	350	#	243
I	311	151	\$	044
J	312	152	%	245
K	113	353	&	246
L	314	154	'	047
M	115	355	(050
N	116	356)	251
O	317	157	*	252
P	120	360	+	053
Q	321	161	,	254
R	322	162	-	055
S	123	363	.	056
T	324	164	/	257
U	125	365	SOH	201
V	126	366	STX	202
W	327	167	ETX	003
X	330	170	EOT	204
Y	131	371	ACK	006
Z	132	372	LF	012
[333	173	GNS	014
≠	134	374	CF	021
]	335	175	NAK	225
†	336	176	ETB	027
█	137	377	CAN	030
0	060		STP	231
1	261		EP	033
2	262		SP	240
3	063		NS	300
4	264			
5	065			
6	066			
7	267			
8	270			
9	071			

Table B-3. Code Conversion
 HEX (ASCII - 8) - CHARACTER

ASCII 8 HEX	ASCII CHAR	ASCII 8 HEX	ASCII CHAR	ASCII 8 HEX	ASCII CHAR
*00	SP	4B	+	B6	V
01	SOH	4C	,	B7	W
02	STX			B8	X
03	ETX	4D	-	B9	Y
04	EOT	4E	.	BA	Z
*05	%	4F	/	BB	[
06	ACK	50	0	BC	≠
*07	'	51	1	BD]
*08	(52	2	BE	†
*09)	53	3	BF	■
0A	LF	54	4	E0	@
*0B	+	55	5	E1	a
0C ⁽³⁾	GNS	56	6	E2	b
*0C ⁽⁴⁾	,	57	7	E3	c
*0D	-	58	8	E4	d
*0E	.	59	9	E5	e
*0F	/	5A	:	E6	f
*10	0	5B	;	E7	g
11	<u>CF</u>	5C	<	E8	h
*12	2	5D	=	E9	i
*13	3	5E	>	EA	j
*14	4	5F	?	EB	k
15	NAK	A0	NS	EC	l
16	SYN	A1	A	ED	m
17	ETB	A2	B	EE	n
18	CAN	A3	C	EF	o
19	<u>STP</u>	A4	D	F0	p
*1A	:	A5	E	F1	q
1B	<u>EP</u>	A6	F	F2	r
*1C	<	A7	G	F3	s
*1D	=	A8	H	F4	t
*1E	>	A9	I	F5	u
*1F	?	AA	J	F6	v
40	SPACE	AB	K	F7	w
41	!	AC	L	F8	x
42	"	AD	M	F9	y
43	#	AE	N	FA	z
44	\$	AF	O	FB	[(1c)
45	%	B0	P	FC	≠ (1c)
46	&	B1	Q	FD] (1c)
47	'	B2	R	FE	† (1c)
48	(B3	S	FF	■ (1c)
49)	B4	T		
4A	*	B5	U		

NOTES:

1. Codes marked * are reserved for future control function assignment.
2. Code 026=16 (HEX)=ASCII SYN must not be used in text--will cause screen erasure and loss of data.
3. Applies to Closed Format only.
4. Applies to Open Format only.

APPENDIX C

CHARACTER GENERATOR

The CHARACTRON[®] shaped beam tube (see Figure C-1) operates on principles fundamental to cathode-ray tubes employed in radar and television. A heated Cathode supplies a cloud of electrons, and a Grid varies the density of the electron flow. The potential between Grid and Cathode also collimates and directs the electrons to produce uniform illumination (coverage) of the Matrix. The Matrix is a metal stencil through which 64 openings have been etched in the shapes of letters, numerals, punctuation marks, and other symbols.

After passing through the Matrix, the electrons emerge as an array of 64 shaped beams "extruded" by the shaped openings. The bundle of 64 shaped beams then passes through electrostatic Lenses, created by A2 and the Matrix. These Lenses are adjusted to form an image (character focus) of the Matrix at the Selection Aperture. Vertical and Horizontal Selection plates deflect the 64-beam bundle so that only the desired single beam can pass through the selection aperture. Additional Lenses L1 and L2 image the aperture (and the CHARACTRON shaped beam) on the Fluorescent Screen. As the single shaped beam passes axially through the magnetic field provided by the Deflection Yoke, it is deflected to correctly position the displayed character on the screen.

A mu metal shield is mounted around the CHARACTRON shaped beam tube to protect it from the detrimental effects of external electromagnetic forces. All tube element controls are on the maintenance panel and are not considered operator controls.

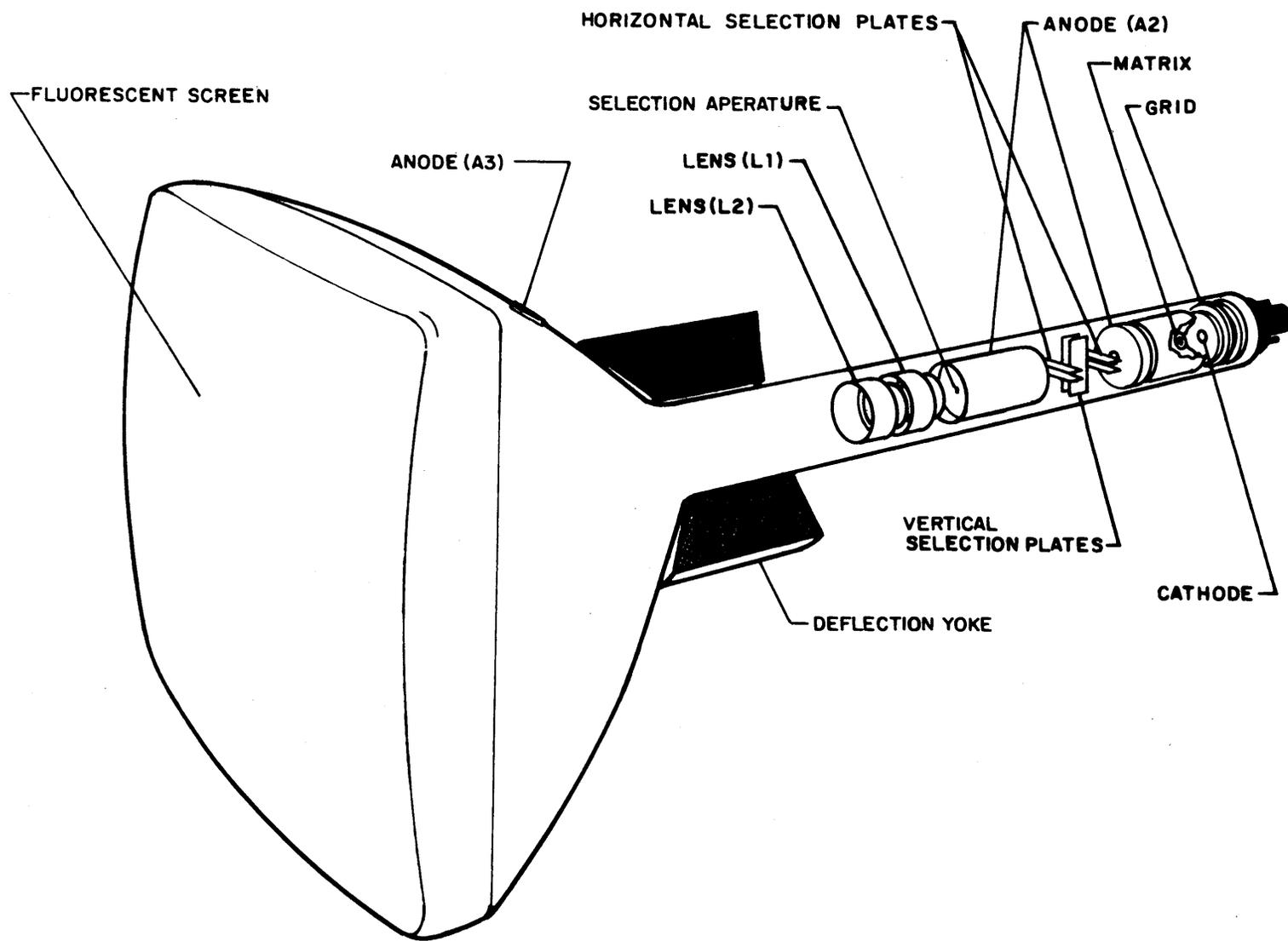

Figure C-1. Basic CHARACTRON Shaped Beam Tube